

### AlphaLink Available PCB Layouts (view from top of board)

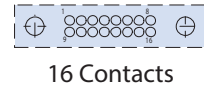
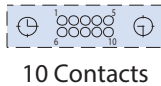

### ALPHALINK® SPRING LOADED CONTACT CONNECTORS TECHNICAL SPECIFICATIONS

Modular contacts set on .050" centers, supplied in double-row contact arrangements. Precision-machined piston / base and gold-plated components assure a 1,000 minimum cycle life. Pistons have a .0275" mid stroke (when fully mated to PC board with a 60 gram/contact force.) Low resistance, high current contacts are rated at 2 amps continuous 3 amps peak. High temperature thermoplastic insulators are suitable for surface mount processes. Contact strips are designed for manual placement into  $\varnothing.023 \pm .003$ " Plated thru-holes in the circuit board. Recommended for board thicknesses of .062" or greater.

#### Materials

Contact piston and base: machined Copper Alloy plated 20 micro inches Gold over 100 micro inches Nickel.  
Spring: Beryllium Copper plated 10 micro inches Gold.  
Insulator: high temp. thermoplastic rated UL94 V-0  
Shell: Aluminum Alloy

#### Shell Finishes

Plating Code 2 = Electroless Nickel (Glenair M code, AMS-C-26074, Class 4 Grade B; ASTM-B-733, SC2, Type IV)  
Plating Code 5 = Gold (Glenair code Z2, MIL-DTL-45204, Class 1 over Electroless Nickel)

#### Electrical

Voltage rating: 100vrms/150vdc  
Current rating: 2A (continuous), 3A (peak) per contact.  
Contact resistance: 20 milliohms maximum.  
Insulation resistance: 5,000 megohms minimum.  
Dielectric strength: 700 vrms minimum.  
Capacitance: 1 pf maximum.

#### Mechanical

Spring force at initial height (a): 25 grams  
Spring force at mid stroke (b/2): 60 grams  
Durability: 1,000 cycles  
Vibration sensitivity: 1.52mm DA or 20g. Duration 4h (in ea. Of 3 axis) per EIA-364-28D  
Shock severity: 100g for 6ms per EIA-364-27B  
Operational temperature: -65°C to +150°C

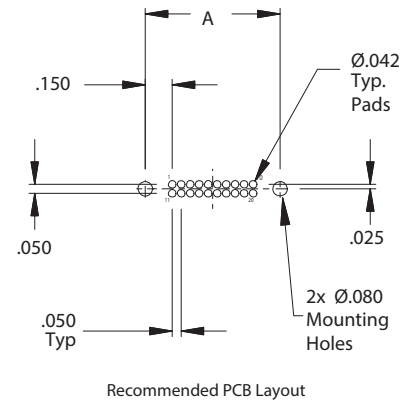

Contacts and Dimensions	
Contacts	A
4	0.350 (8.9)
8	0.450 (11.4)
10	0.500 (12.7)
12	0.550 (14.0)
16	0.650 (16.5)
20	0.750 (19.1)
24	0.850 (21.6)
28	0.950 (24.1)
30	1.000 (25.4)
32	1.050 (26.7)
36	1.150 (29.2)
40	1.250 (31.8)

# AlphaLink® SL connector with spring loaded contacts and solder cups



171-134-01

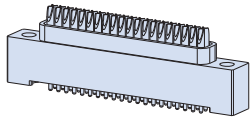

How To Order 171-134-01				
Sample Part Number	171-134-01	2	-10	T
Series / Basic Part No.	AlphaLink® SL connector with spring loaded contacts and solder cups			
Shell Finish	2 = Nickel 5 = Gold			
Contact Layout	See Table I and Contact Arrangements, page 4			
Hardware	T = Threaded thru hole Omit for thru hole			

B

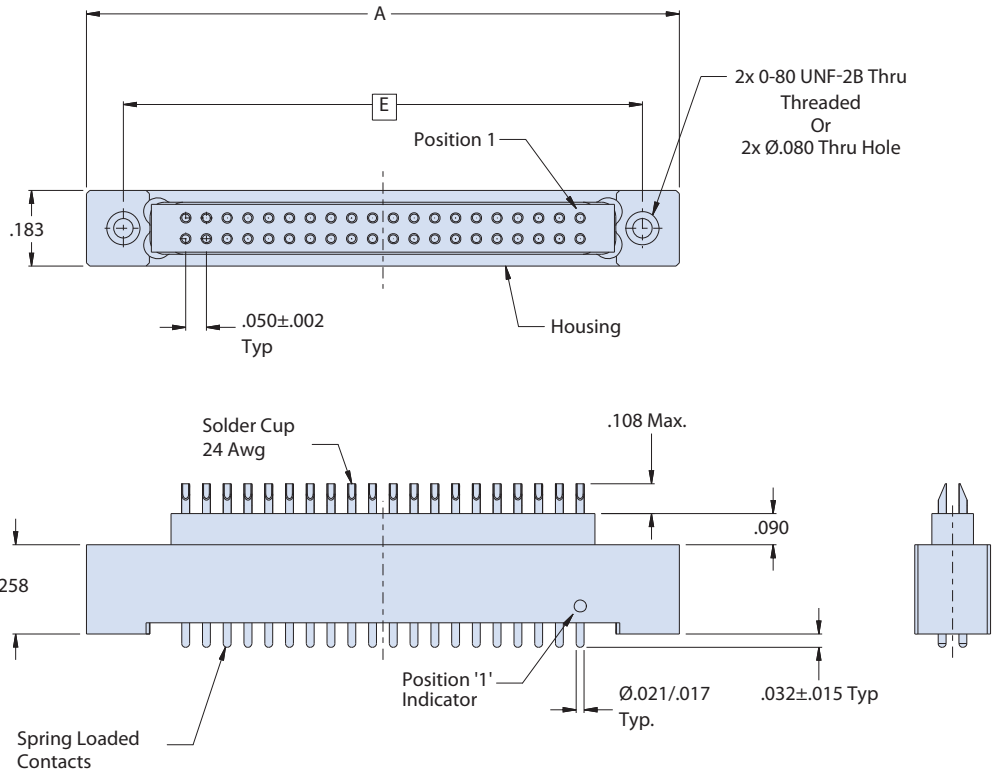

No. of contacts	A	E
4	0.527 (13.4)	0.350 (8.9)
8	0.627 (15.9)	0.450 (11.4)
10	0.677 (17.2)	0.500 (12.7)
12	0.727 (18.5)	0.550 (14.0)
16	0.827 (21.0)	0.650 (16.5)
20	0.927 (23.5)	0.750 (19.1)
24	1.027 (26.1)	0.850 (21.6)
28	1.127 (28.6)	0.950 (24.1)
30	1.177 (29.9)	1.000 (25.4)
32	1.227 (31.2)	1.050 (26.7)
36	1.327 (33.7)	1.150 (29.2)
40	1.427 (36.2)	1.250 (31.8)

Compatible Wire
AS22759 qualified single-ended data transmission wire for termination of AlphaLink® SL solder-cup connectors—see page 42 of this catalog

### MATERIALS AND FINISHES

Shell: Aluminum Alloy  
 Insulator: High-temperature thermoplastic rated UL94 V-0  
 Contacts: Copper Alloy/Gold Plated

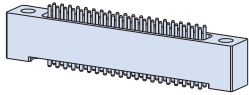

B

How To Order 171-134-02				
Sample Part Number	171-134-02	2	-10	T
Series / Basic Part No.	AlphaLink® SL connector with spring loaded contacts and PC tails			
Shell Finish	2 = Nickel 5 = Gold			
Contact Layout	See Table I and Contact Arrangements, page 4			
Hardware	T = Threaded thru hole Omit for thru hole			

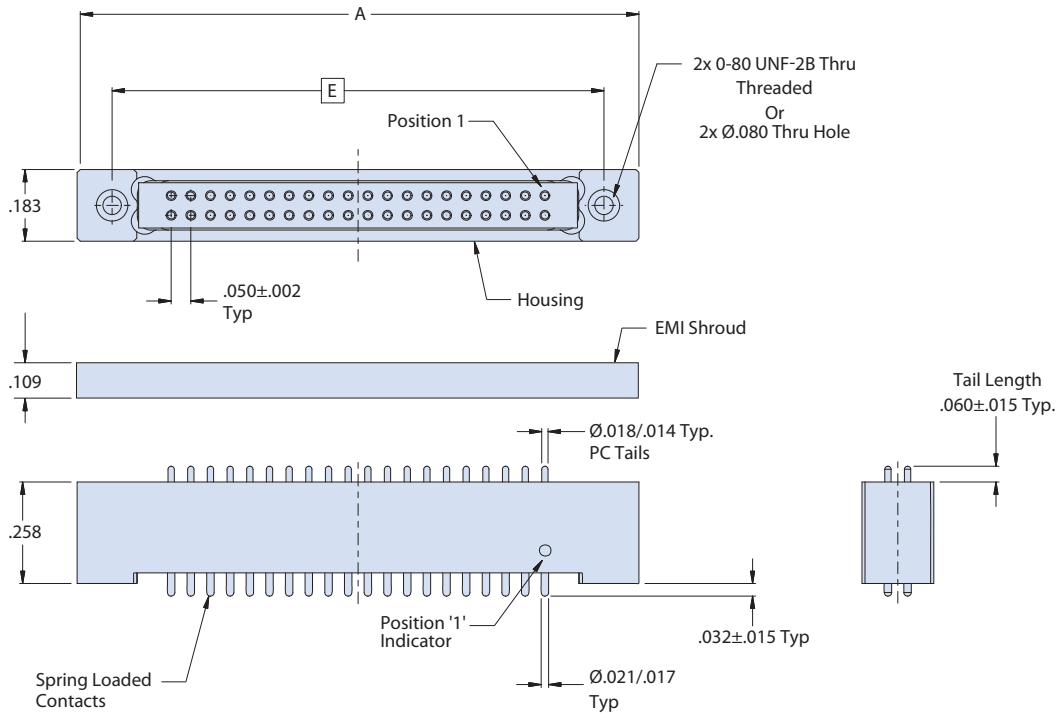

No. of contacts	A	E
4	0.527 (13.4)	0.350 (8.9)
8	0.627 (15.9)	0.450 (11.4)
10	0.677 (17.2)	0.500 (12.7)
12	0.727 (18.5)	0.550 (14.0)
16	0.827 (21.0)	0.650 (16.5)
20	0.927 (23.5)	0.750 (19.1)
24	1.027 (26.1)	0.850 (21.6)
28	1.127 (28.6)	0.950 (24.1)
30	1.177 (29.9)	1.000 (25.4)
32	1.227 (31.2)	1.050 (26.7)
36	1.327 (33.7)	1.150 (29.2)
40	1.427 (36.2)	1.250 (31.8)

### MATERIALS AND FINISHES

Shell: Aluminum alloy  
 Insulator: High-temperature thermoplastic rated UL94 V-0  
 Contacts: Copper Alloy/Gold Plated

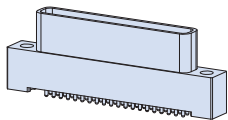

How To Order 171-134-03							
<b>Sample Part Number</b>	<b>171-134-03</b>	<b>2</b>	<b>-10</b>	<b>-4</b>	<b>K</b>	<b>7</b>	<b>-18 T</b>
<b>Series / Basic Part No.</b>	AlphaLink® SL connector with spring loaded contacts and pigtail wires						
<b>Shell Finish</b>	2 = Nickel 5 = Gold						
<b>Contact Layout</b>	See Table I and Contact Arrangements, page 4						
<b>Wire Gage (AWG)</b>	4 = #24 6 = #26 8 = #28 0 = #30						
<b>Wire Type</b>	K = M22759/11 (#24-#28) J = M22759/33 (#24-#30)						
<b>Wire Color Code</b>	1 = White 7 = Ten Color Repeat						
<b>Wire Length</b>	In inches						
<b>Hardware</b>	T = Threaded thru hole Omit for thru hole						

B

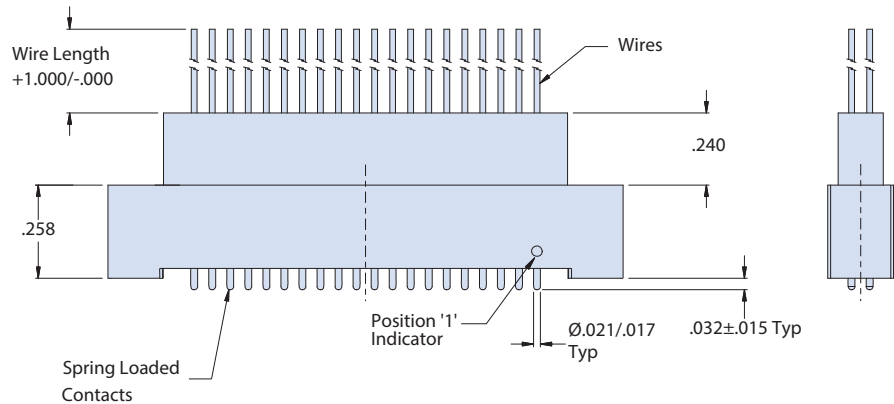
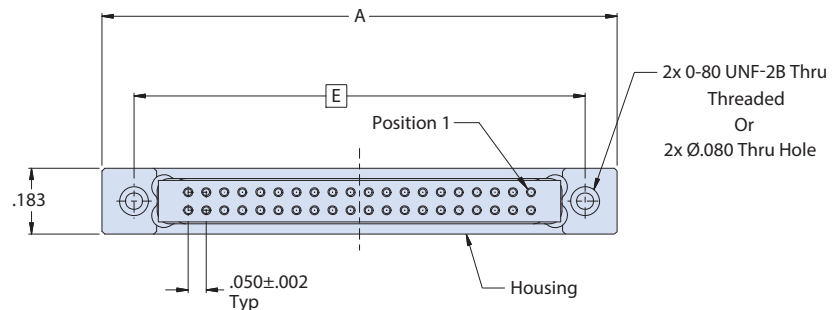

No. of contacts	A	E
4	0.527 (13.4)	0.350 (8.9)
8	0.627 (15.9)	0.450 (11.4)
10	0.677 (17.2)	0.500 (12.7)
12	0.727 (18.5)	0.550 (14.0)
16	0.827 (21.0)	0.650 (16.5)
20	0.927 (23.5)	0.750 (19.1)
24	1.027 (26.1)	0.850 (21.6)
28	1.127 (28.6)	0.950 (24.1)
30	1.177 (29.9)	1.000 (25.4)
32	1.227 (31.2)	1.050 (26.7)
36	1.327 (33.7)	1.150 (29.2)
40	1.427 (36.2)	1.250 (31.8)

### MATERIALS AND FINISHES

Shell: Aluminum alloy  
 Insulator: High-temperature thermoplastic rated UL94 V-0  
 Contacts: Copper Alloy/Gold Plated