

MIL-STD-1669 Insert Arrangements (Pin Front View) and Insert Positions for MIL-DTL-26482 Series II Type Filter Connectors

B



8-2
2X #20



8-3
3X #20



8-4
4X #20



8-33
3X #20



8-98
3X #20

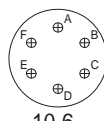

10-6
6X #20

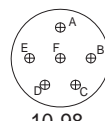

10-98
6X #20

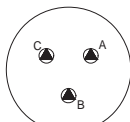

12-3
3X #16

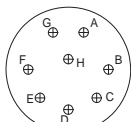

12-8
8X #20

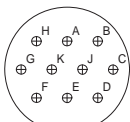

12-10
10X #20

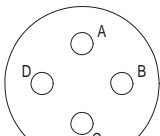

14-4
4X #12

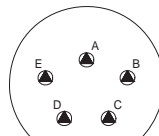

14-5
5X #16

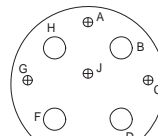

14-9
4X #12/5X #20

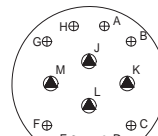

14-12
4X #16/8X #20

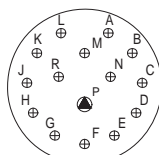

14-15
1X #16/14X #20

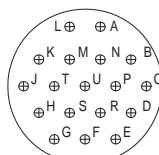

14-18
18X #20

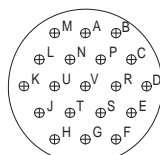

14-19
19X #20

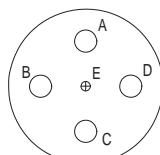

14-22
4X #12/1X #20

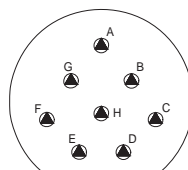

16-8
8X #16

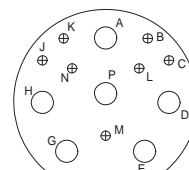

16-14
6X #12/8X #20

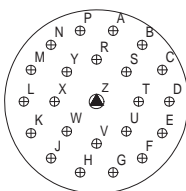

16-23
1X #16/22X #20

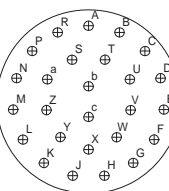

16-26
26X #20

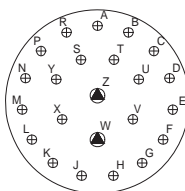

16-99
2X #16/21X #20

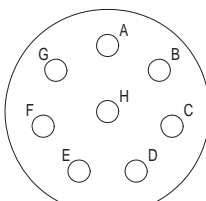

18-8
8X #12

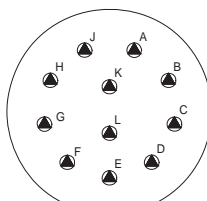

18-11
11X #16

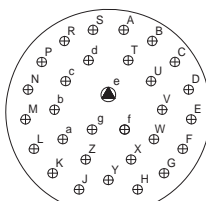

18-30
1X #16/29X #20

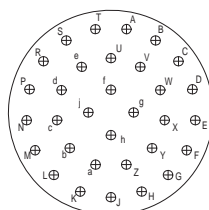

18-32
32X #20

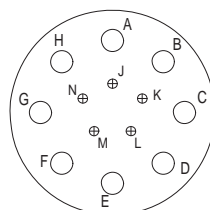

18-85
8X #12/5X #20

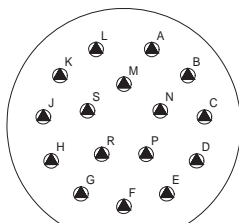

20-16
16X #16

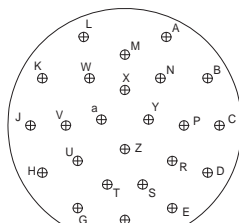

20-24
24X #20

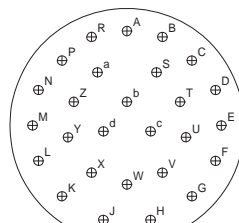

20-27
27X #20

SYM	SIZE
⊕	#20
⊖	#16
○	#12

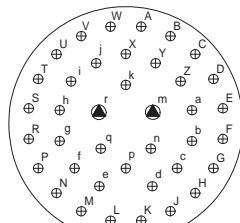

20-39
2X #16/37X #20

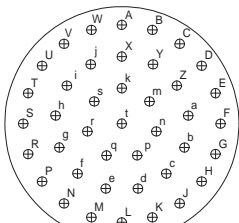

20-41
41X #20

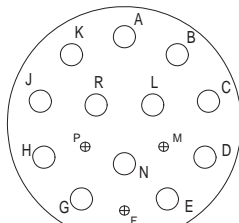

20-90
12X #12/3X #20

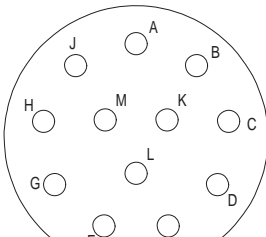

22-12
12X #12

Dimensions in inches (millimeters) and are subject to change without notice.

MIL-STD-1669 Insert Arrangements (Pin Front View) and Insert Positions for MIL-DTL-26482 Series II Type Filter Connectors



MIL-DTL-26482
Type

B

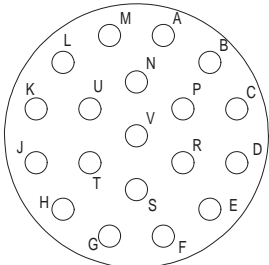

22-19
19X #12

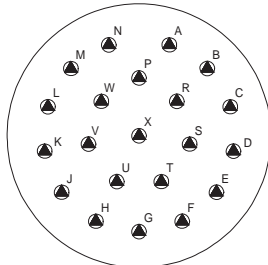

22-21
21X #16

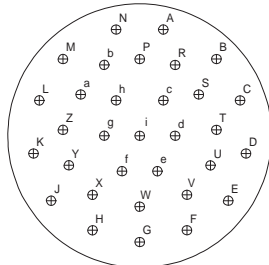

22-32
32X #20

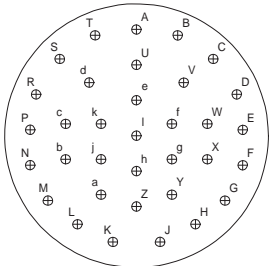

22-34
34X #20

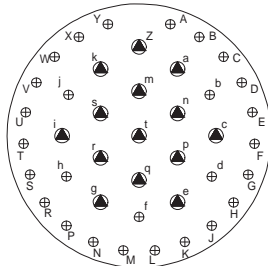

22-41
14X #16/27X #20

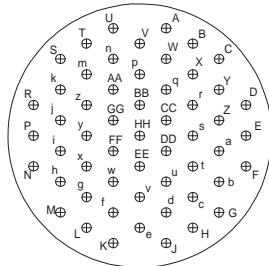

22-55
55X #20

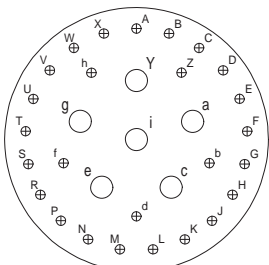

22-95
6X #12/26X #20

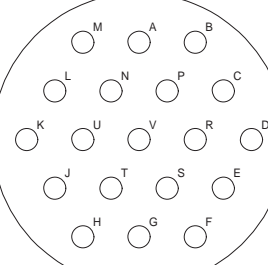

24-19
19X #12

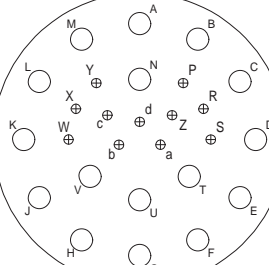

24-27
16X #12/11X #20

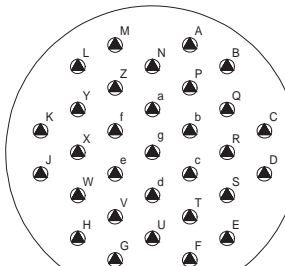

24-31
31X #16

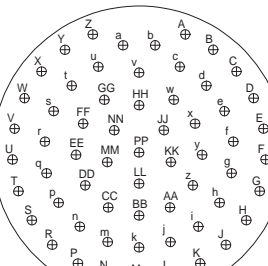

24-61
61X #20

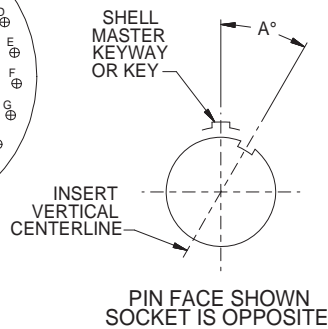

SYM	SIZE
⊕	#20
▲	#16
○	#12

NOTE: SHELL KEYS & KEYWAYS REMAIN FIXED WHILE THE INSERT IS ROTATED RELATIVE TO THE CENTERLINE OF THE MASTER KEY OR KEYWAY (POSITION N = 0°).

MIL-DTL-26482 Series II Insert Positions					
Insert Arrg.	A°				
	N°	W°	X°	Y°	Z°
8-2	0°	58°	122°	-	-
8-3	0°	60°	210°	-	-
8-4	0°	45°	-	-	-
8-33	0°	90°	-	-	-
8-98	0°	-	-	-	-
10-6	0°	90°	-	-	-
10-98	0°	90°	180°	240°	270°
12-3	0°	-	-	180°	-
12-8	0°	90°	112°	203°	292°
12-10	0°	60°	155°	270°	295°
14-4	0°	45°	-	-	-
14-5	0°	40°	92°	184°	273°
14-9	0°	15°	90°	180°	240°
14-12	0°	43°	90°	-	-
14-15	0°	17°	110°	155°	234°
14-18	0°	15°	90°	180°	270°
14-19	0°	30°	165°	315°	-
14-22	0°	45°	-	-	-
16-8	0°	54°	152°	180°	331°
16-14	0°	25°	78°	180°	240°
16-23	0°	158°	270°	-	-
16-26	0°	60°	-	275°	338°
16-99	0°	66°	156°	223°	340°
18-8	0°	180°	-	-	-
18-11	0°	62°	119°	241°	340°
18-30	0°	180°	193°	285°	350°
18-32	0°	85°	138°	222°	265°
18-85	0°	45°	90°	180°	240°
20-16	0°	238°	318°	333°	347°
20-24	0°	70°	145°	215°	290°
20-27	0°	72°	144°	216°	288°
20-39	0°	83°	144°	252°	333°
20-41	0°	45°	126°	225°	-
20-90	0°	18°	60°	240°	270°
22-12	0°	-	-	-	-
22-19	0°	15°	90°	225°	308°
22-21	0°	16°	135°	175°	349°
22-32	0°	72°	145°	215°	288°
22-34	0°	62°	142°	218°	298°
22-41	0°	39°	135°	264°	-
22-55	0°	30°	142°	226°	314°
22-95	0°	26°	180°	266°	-
24-19	0°	30°	165°	315°	-
24-27	0°	45°	110°	140°	225°
24-31	0°	90°	225°	255°	-
24-61	0°	90°	180°	270°	324°

Dimensions in inches (millimeters) and are subject to change without notice.

© 2013 Glenair, Inc.

U.S. CAGE Code 06324

Printed in U.S.A.