

NEXT-GENERATION
HIGH-SPEED
MICRO
MINIATURE
CONNECTORS

SERIES
806
MIL-AERO

Advanced performance,
reduced size and weight
connector series IAW
MIL-DTL-38999



Innovative design meets key performance benchmarks for harsh vibration, shock, and environmental settings—as well as high-altitude, unpressurized aircraft zones with aggressive voltage ratings and altitude immersion standards.

El Ochito®

- High-speed Ethernet, USB 3.0, HDMI, and DisplayPort
- Next-generation small form factor aerospace-grade circular connector
- Upgraded environmental, electrical and mechanical performance
- Integrated anti-decoupling technology
- High-Speed El Ochito® and hybrid #22HD contact arrangements

SAVE SIZE AND WEIGHT WITH SERIES 806 CONNECTORS

Series 806 Mil-Aero
Smallest Size
.500 In. Mating Threads
3 #20 Contacts or 7 #22
contacts



MIL-DTL-38999
Smallest Size
.625 In. Mating Threads
3 #20 Contacts or 6 #22
contacts

HIGH-SPEED Series 806 Mil-Aero Micro Miniature Circular Connectors with El Ochito® octaxial contacts



Series 806 with El Ochito® contact arrangements

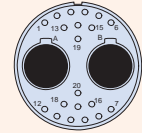
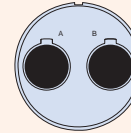
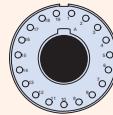
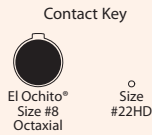

Insert Arrangement
No. of Contacts

10-1
1x #8

14-20A
1x #8 | 19x #22HD

16-2
2x #8

16-22
2x #8 | 20x #22HD

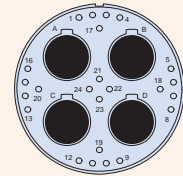
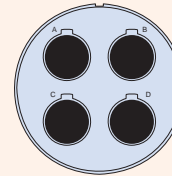
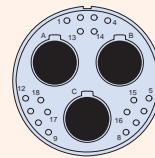
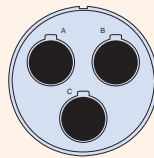
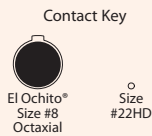

Insert Arrangement
No. of Contacts

18-3
3x #8

18-21
3x #8 | 18x #22HD

20-4
4x #8

20-28
4x #8 | 24x #22HD

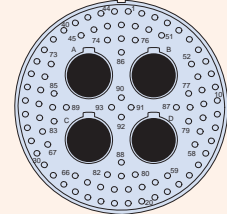
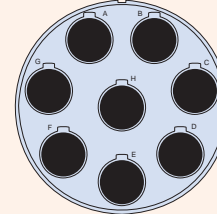
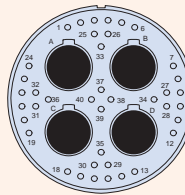
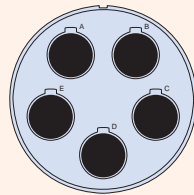
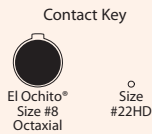

Insert Arrangement
No. of Contacts

22-5
5x #8

22-44
4x #8 | 40x #22HD

24-8
8x #8

24-97
4x #8 | 93x #22HD

Polarizing Positions

Position	A°	B°	C°	D°
A	105	140	215	265
B	102	170	248	305
C	80	150	230	295
D	68	140	205	275
E	64	155	234	304
F	72	120	200	298

FEATURES

- Triple-start stub ACME mating thread
- El Ochito® Octaxial and hybrid High density #22HD arrangements for reduced size / weight and high-speed performance
- Aerospace-grade materials, construction, and performance

CONNECTOR CONSTRUCTION

- Shell and coupling nut: aluminum or stainless steel
- Contacts: copper alloy, gold plating
- Wire grommet: fluorosilicone
- Dielectric inserts: high grade rigid dielectric
- Peripheral seal: fluorosilicone
- Ground spring: copper alloy, nickel plating
- Contact retention clips: copper alloy
- Ratchet springs: stainless steel, passivated
- Retainer rings: stainless steel, passivated
- Clinch nuts: stainless steel, passivated

RECOMMENDED BACKSHELL

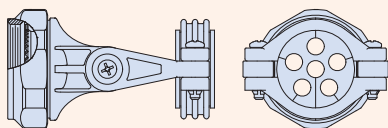

627-259

Swing-Arm 3-in-1 strain relief
with cable bushing (consult factory)

HIGH-SPEED Series 806 Mil-Aero Micro Miniature Circular Connectors with El Ochito® octaxial contacts

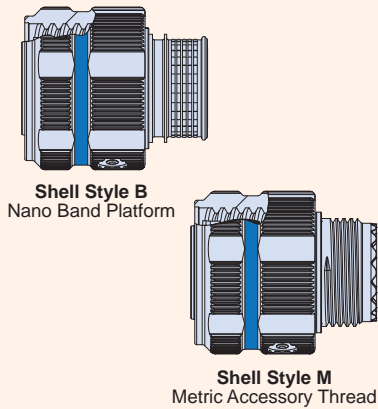

How To Order Series 806 El Ochito® Plugs						
SAMPLE PART NUMBER	806-012	-ME	18-3	S	M	A
Product	806-012 = Cable Plug					
Shell Material and Finish	ME = Aluminum, Electroless Nickel MT = Aluminum, Ni/PTFE ZR = Aluminum, Black Zinc-Nickel NF = Aluminum, Olive Drab Cadmium Z1 = Stainless Steel, Passivated					
Arrangement Number (Shell Size - Insert Arr.)	See Contact Arrangements Table					
Contact Type	P = Pin S = Socket					
Shell Style	M = Metric accessory threads B = Nano Band platform					
Polarizing Position	A B C D E F					

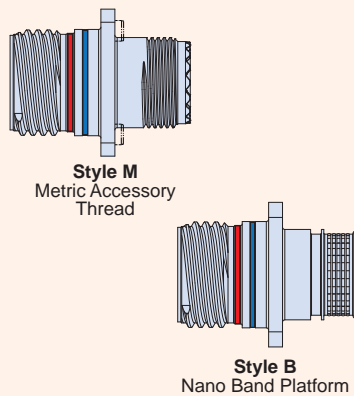

How To Order Series 806 El Ochito® Square Flange Receptacles							
SAMPLE PART NUMBER	806-013	-MT	18-21	P	B	C	A
Product	806-013 = Panel Receptacle, Square Flange, Crimp						
Shell Material and Finish	ME = Aluminum, Electroless Nickel MT = Aluminum, Ni/PTFE ZR = Aluminum, Black Zinc-Nickel NF = Aluminum, Olive Drab Cadmium Z1 = Stainless Steel, Passivated						
Arrangement Number (Shell Size - Insert Arr.)	See Contact Arrangements Table						
Contact Type	P = Pin S = Socket						
Shell Style	M = Metric accessory threads B = Nano Band platform						
Mounting Hole Style	T = Thru holes C = Clinch nut, #4-40 (rear panel mounting)						
Polarizing Position	A B C D E F						

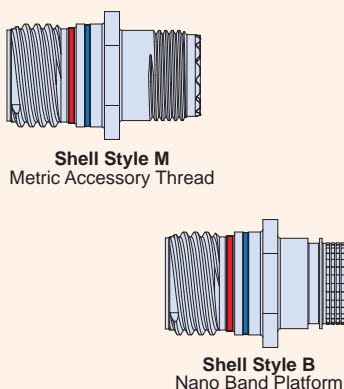

How To Order Series 806 El Ochito® In-Line Receptacles						
SAMPLE PART NUMBER	806-019	-MT	18-21	P	B	A
Product	806-019 = In-Line Receptacle					
Shell Material and Finish	ME = Aluminum, Electroless Nickel MT = Aluminum, Ni/PTFE ZR = Aluminum, Black Zinc-Nickel NF = Aluminum, Olive Drab Cadmium Z1 = Stainless Steel, Passivated					
Arrangement Number (Shell Size - Insert Arr.)	See Contact Arrangements Table					
Contact Type	P = Pin S = Socket					
Shell Style	M = Metric accessory threads B = Nano Band platform					
Polarizing Position	A B C D E F					

HIGH-SPEED Series 806 Mil-Aero Micro Miniature Circular Connectors with El Ochito® octaxial contacts

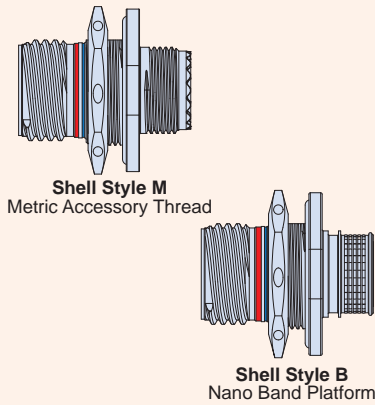

How To Order Series 806 El Ochito® Jam Nut Receptacles							
SAMPLE PART NUMBER		806-020	-MT	18-21	P	B	A
Product	806-020 = Jam Nut Receptacle						
Shell Material and Finish	ME = Aluminum, Electroless Nickel MT = Aluminum, Ni/PTFE ZR = Aluminum, Black Zinc-Nickel NF = Aluminum, Olive Drab Cadmium Z1 = Stainless Steel, Passivated						
Arrangement Number (Shell Size - Insert Arr.)	See Contact Arrangements Table						
Contact Type	P = Pin S = Socket						
Shell Style	M = Metric accessory threads B = Nano Band platform						
Polarizing Position	A B C D E F						

Table VI - Ochito Contact Positions

B = Blue, R = Red, W = White

SYM	El Ochito Contact Designator							
	A	B	C	D	E	F	G	H
E	W	W	W	W	W	W	W	W
E2	B	W	W	W	W	W	W	W
E3	R	W	W	W	W	W	W	W
E4	B	B	W	W	W	W	W	W
E5	R	B	W	W	W	W	W	W
E6	R	R	W	W	W	W	W	W
E7	B	B	B	W	W	W	W	W
E8	R	B	B	W	W	W	W	W
E9	R	R	B	W	W	W	W	W
E10	R	R	R	W	W	W	W	W
E11	B	B	B	B	W	W	W	W
E12	R	B	B	B	W	W	W	W
E13	R	R	B	B	W	W	W	W
E14	R	R	R	B	W	W	W	W
E15	R	R	R	R	W	W	W	W
E16	B	B	B	B	B	W	W	W
E17	R	B	B	B	B	W	W	W
E18	R	R	B	B	B	W	W	W
E19	R	R	R	B	B	W	W	W
E20	R	R	R	R	B	W	W	W
E21	R	R	R	R	R	W	W	W
E22	B	B	B	B	B	B	W	W
E23	R	B	B	B	B	B	W	W
E24	R	R	B	B	B	B	W	W
E25	R	R	R	B	B	B	W	W
E26	R	R	R	R	B	B	W	W
E27	R	R	R	R	R	B	W	W
E28	R	R	R	R	R	R	W	W
E29	B	B	B	B	B	B	B	W
E30	R	B	B	B	B	B	B	W
E31	R	R	B	B	B	B	B	W
E32	R	R	R	B	B	B	B	W
E33	R	R	R	R	B	B	B	W
E34	R	R	R	R	R	B	B	W
E35	R	R	R	R	R	R	B	W
E36	R	R	R	R	R	R	R	W
E37	B	B	B	B	B	B	B	B
E38	R	B	B	B	B	B	B	B
E39	R	R	B	B	B	B	B	B
E40	R	R	R	B	B	B	B	B
E41	R	R	R	R	B	B	B	B
E42	R	R	R	R	R	B	B	B
E43	R	R	R	R	R	R	B	B
E44	R	R	R	R	R	R	R	B
E45	R	R	R	R	R	R	R	R

How To Order Series 806 El Ochito® PCB Receptacles										
SAMPLE PART NUMBER		806-039	-MT	14	E	-	18-21	P		A
Product	806-039 = Jam Nut 806-040 = Square-Flange									
Shell Material and Finish	ME = Aluminum, Electroless Nickel MT = Aluminum, Ni/PTFE ZR = Aluminum, Black Zinc-Nickel NF = Aluminum, Olive Drab Cadmium Z1 = Stainless Steel, Passivated									
Shell Size	10, 14, 16, 18, 20, 22, 24									
Contact Type	See Table VI									
Ground Option	G = Common Ground - = None									
Contact Arrangement Number	See Contact Arrangements Table									
Contact Gender	P = Pin S = Socket									
Panel Mount Thru-Hole Style	(for 806-040 square-flange only) T = Thru-Hole C = Clinch Nuts for Rear Panel Mount Omit for 806-039 Jam Nut									
Polarizing Position	A B C D E F									

