

SERIES 28 HiPer-D® Combo Connectors

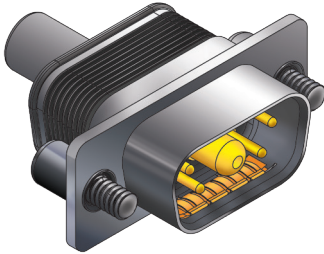

280-088P combo cable pin connectors with standard mounting flange, integral banding platform and crimp termination



Combo HiPer-D® Combo-D connectors, with integral banding platform, feature size #20 signal contacts and size #8 power or coax contacts. **Size #8 contacts are ordered separately.** The HiPer-D® features a rugged machined aluminum shell and wire grommet for environmental protection. Size #20 contacts are packaged with connector. Terminate contacts with crimp tools purchased separately. Glass-reinforced thermoset epoxy insulators, copper alloy retention clips. Fluorosilicone rear grommet meets IP67 immersion requirement. 1000 VAC, 7.5 Amps (#20), up to 40 Amps with size #8 power contacts.

How To Order						
Sample Part Number	280-088	P	1-5W1	ME	G	S
Basic Part Number	280-088					
Contact	P = Pin		A - Less contact			
Shell Size-Contact Arrangement	Contact arrangements are shown in the adjacent table					
Shell Finish	ME = Electroless Nickel		MT = Nickel-PTFE			
	Z1 = Passivated Stainless Steel		ZM = Nickel Over Stainless			
Ground Option	G = EMI/Grounding			N = None		
Mating Hardware	N = No Hardware		P = Female Jackpost			
	L = Low Profile Hex Head Captive Jackscrew		K = Slot Head Extended Jackscrew			
	S = Hex Head Captive Screwlock		T = Slot Head Extended Captive Screwlock			

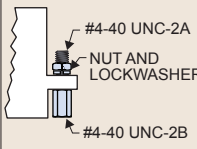
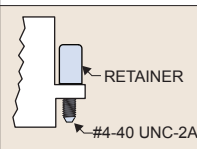
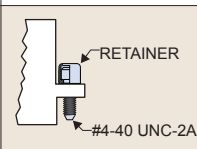
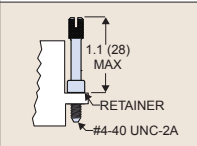
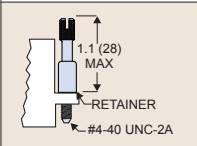
Mating Hardware	
N Thru-Hole No Hardware 	P Female Jackpost 
S Captive Screwlock, Hex Head 	L Captive Jackscrew, Hex Head 
K Slot-Head Extended Jackscrew 	T Slot-Head Extended Captive Screwlock 

Shell Size-Contact Arr.	Contact Size and Qty		
	#22	#20	#8
1-2W2			2
1-5W1		4	1
2-3W3			3
2-7W2		5	2
2-11W1		10	1
3-5W5			5
3-9W4		5	4
3-13W3		10	3
3-17W2		15	2
3-21W1		20	1
4-8W8			8
4-13W6		7	6
4-17W5		12	5
4-21WA4		17	4
4-25W3		22	3
4-27W2		25	2
5-24W7		17	7
5-36W4		32	4
5-43W2		41	2
5-47W1		46	1

Specifications	
Current Rating	#20 7.5 AMPS, #8 40 AMPS
Test Voltage	1000 VAC RMS
Insulation Resistance	5000 megohms minimum
Operating Temperature	-65° C. to +200° C.
Ingress Protection	IP 67
Shock	300 g.
Vibration, Random	43.92 g.

Materials and Finishes	
Shell	Aluminum alloy
Contacts	Copper alloy, 50 microinches gold
Insulators	Thermoset epoxy
Retention Clips	Copper alloy
Grommet, O-ring	Fluorosilicone rubber
Hardware	300 series stainless steel

SERIES 28 HiPer-D® Combo Connectors



280-088P combo cable pin connectors with standard mounting flange, integral banding platform and crimp termination

280-088P DIMENSIONS

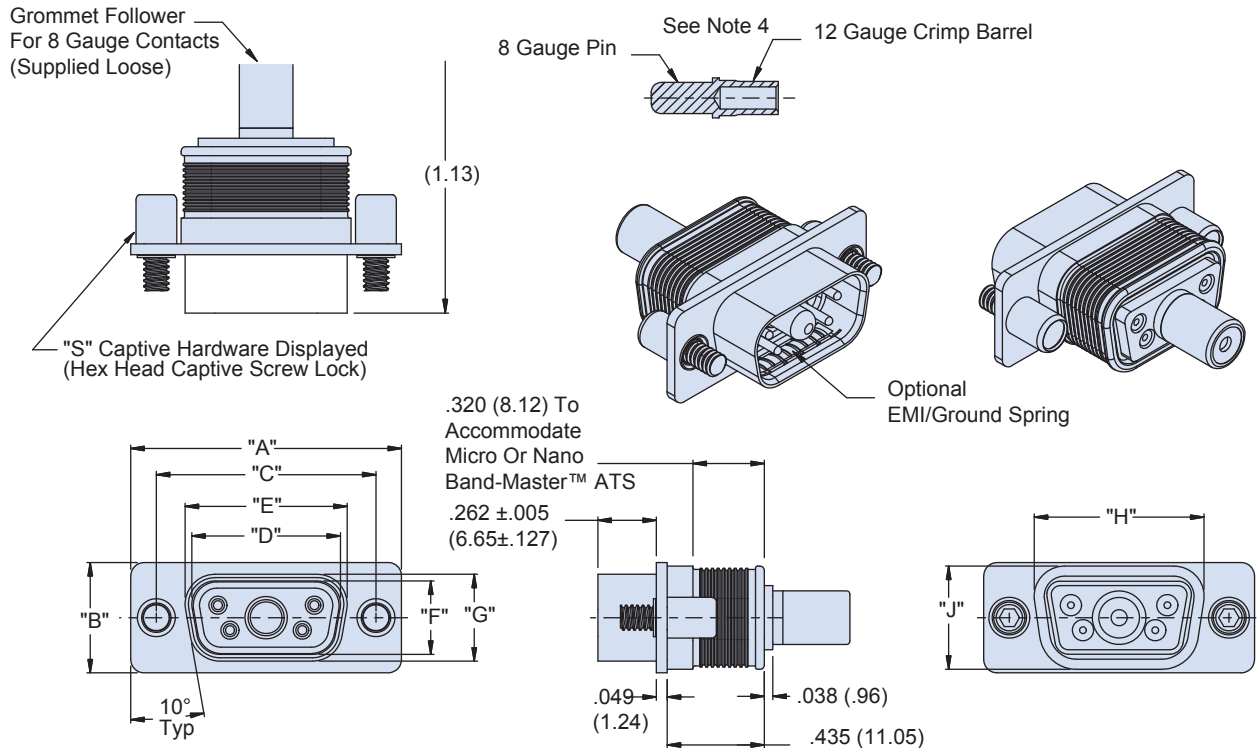

Dimensions																		
Shell Size	"A" ±.015		"B" ±.015		"C" ±.005		"D" ±.005		"E" ±.005		"F" ±.005		"G" ±.005		"H"		"J"	
	In.	mm.	In.	mm.	In.	mm.	In.	mm.	In.	mm.	In.	mm.	In.	mm.	In.	mm.	In.	mm.
1	1.213	30.81	0.494	12.55	0.984	24.99	0.666	16.92	0.726	18.44	0.329	8.36	0.389	9.88	0.760	19.30	0.462	11.73
2	1.541	39.14	0.494	12.55	1.312	33.32	0.994	25.25	1.054	26.77	0.329	8.36	0.389	9.88	1.089	27.66	0.462	11.73
3	2.088	53.04	0.494	12.55	1.852	47.04	1.534	38.96	1.594	40.48	0.329	8.36	0.389	9.88	1.629	41.38	0.462	11.73
4	2.729	69.32	0.494	12.55	2.5	63.50	2.182	55.42	2.242	56.94	0.329	8.36	0.389	9.88	2.277	57.84	0.462	11.73
5	2.635	66.93	0.605	15.37	2.406	61.11	2.079	52.81	2.139	54.33	0.441	11.20	0.501	12.73	2.182	55.42	0.474	12.04
6	2.729	69.32	0.668	16.97	2.5	63.50	2.212	56.18	2.272	57.71	0.503	12.77	0.563	14.30	2.307	58.60	0.626	15.90

NOTES

1. See [About Series 28 HiPer-D® Shell Plating Options](#) for additional shell material and finish options. Glenair offers the industry's widest selection of plating options with no minimum order quantities or setup charges.
2. For panel cutouts, refer to [Panel Cutouts and Printed Circuit Board Footprints](#).
3. Connectors are supplied with size #20 crimp contacts per M39029. Contacts are not installed. Refer to [HiPer-D® Contacts and Tools](#) section for contact part numbers, specifications, crimp tool information, and insertion/extraction tools.
4. **Size 8 contacts are ordered separately.** Refer to [HiPer-D® Contacts and Tools](#) section for contact ordering information, specifications, crimp tool information, and insertion/extraction tools.
5. Combo HiPer-D® connectors meet the applicable requirements of MIL-DTL-24308 and are intermateable with standard non-environmental D Subminiature connectors with corresponding contact arrangements and type. **Size 8 contacts from other manufacturers cannot be installed in HiPer-D® connectors.**
6. Additional electrical, mechanical and environmental specifications are listed in [HiPer-D® Product Specification](#).