

PCB FOOTPRINT FOR 280-050P AND 280-054P COMBO CONNECTORS

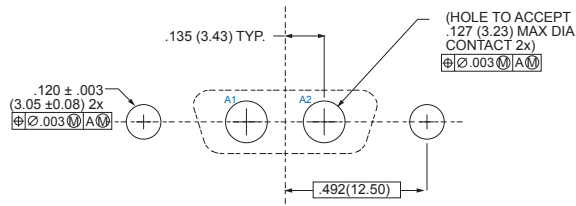

1-2P2
2 #8

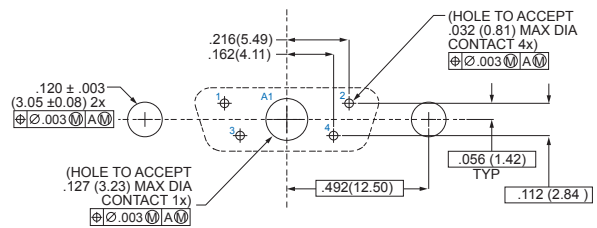

1-5P1
1 #8, 4 #20

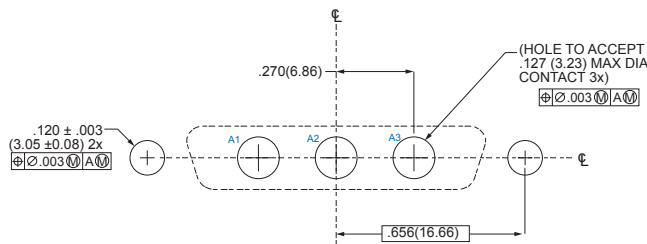

2-3P3
3 #8

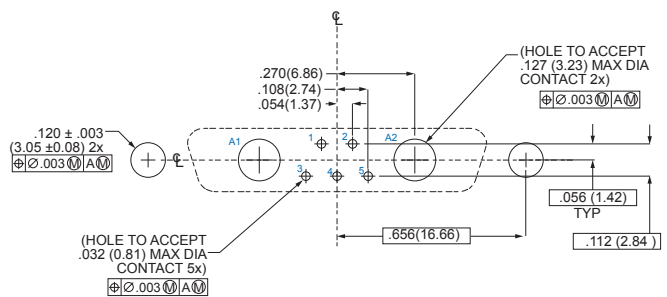

2-7P2
2 #8, 5 #20

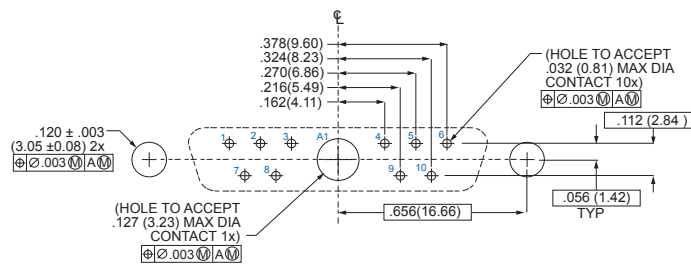

2-11P1
1 #8, 10 #20

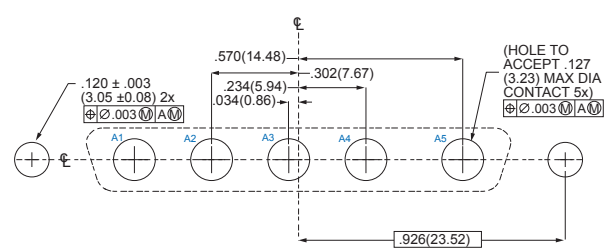

3-5P5
5 #8

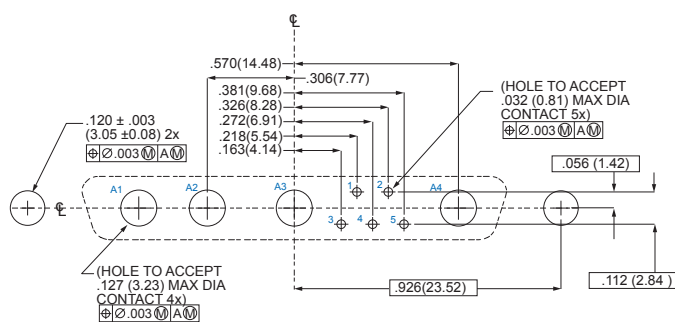

3-9P4
4 #8, 5 #20

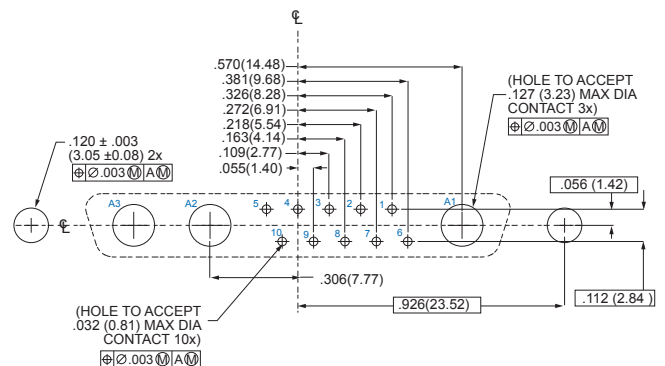

3-13P3
3 #8, 10 #20

PCB footprints for combo pin connectors with straight PC tails

PCB FOOTPRINT FOR 280-050P AND 280-054P COMBO CONNECTORS

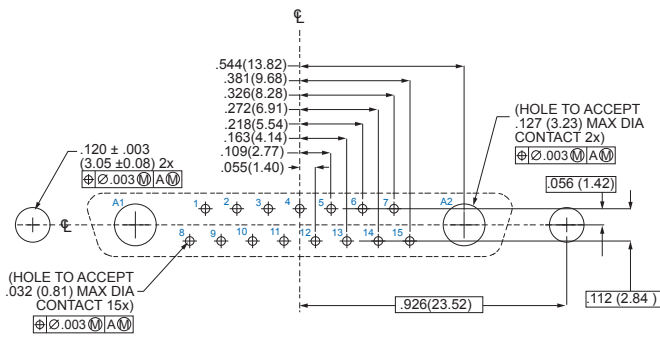

3-17P2
2 #8, 15 #20

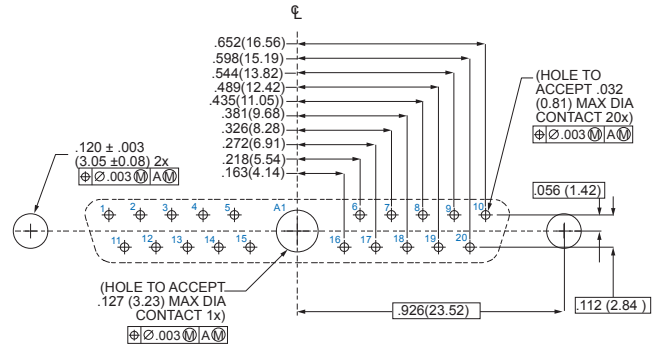

3-21P1
1 #8, 20 #20

4-8P8
8 #8

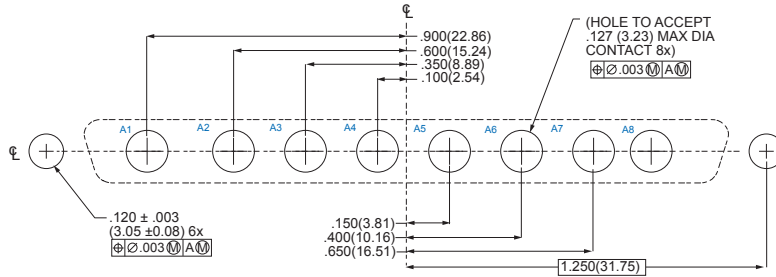

4-13P6
6 #8, 7 #20

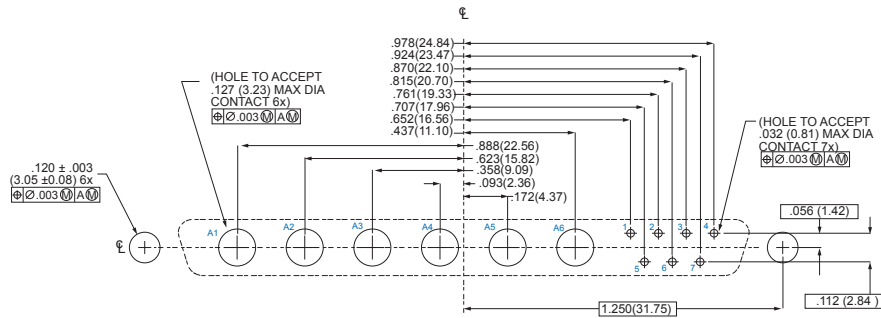

4-17P5
5 #8, 12 #20

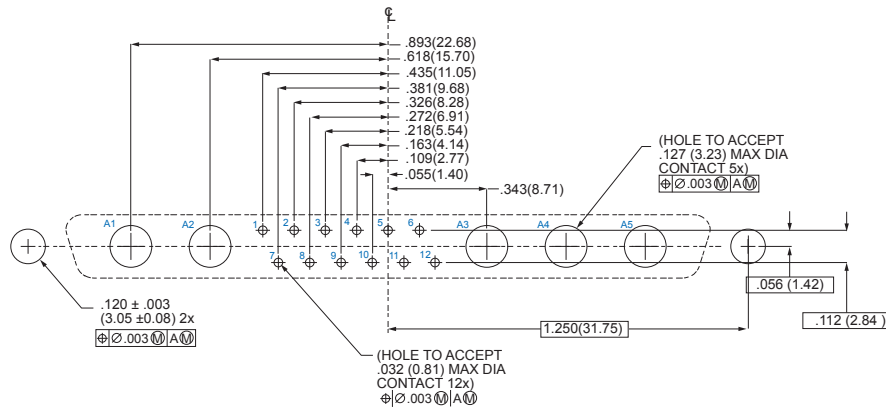

PCB FOOTPRINT FOR 280-050P AND 280-054P COMBO CONNECTORS

4-21PA4
4 #8, 17 #20

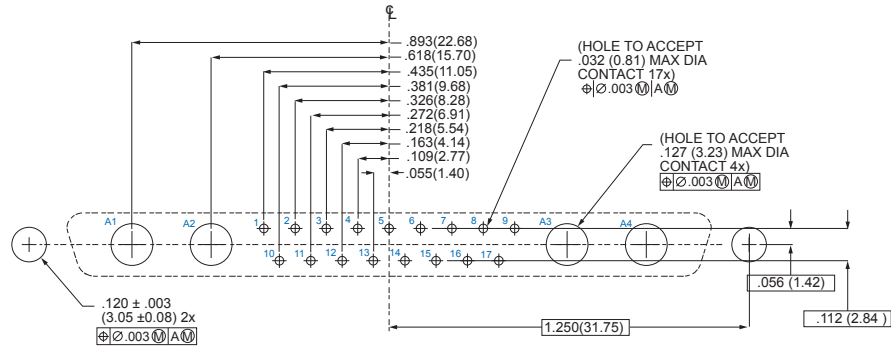

4-25P3
3 #8, 22 #20

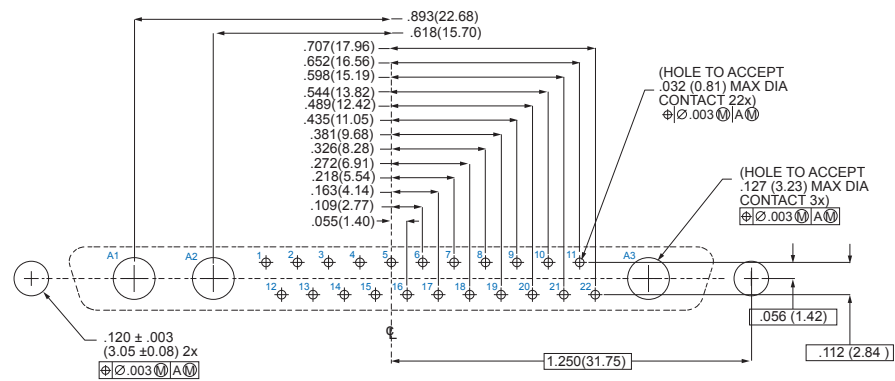

4-27P2
2 #8, 25 #20

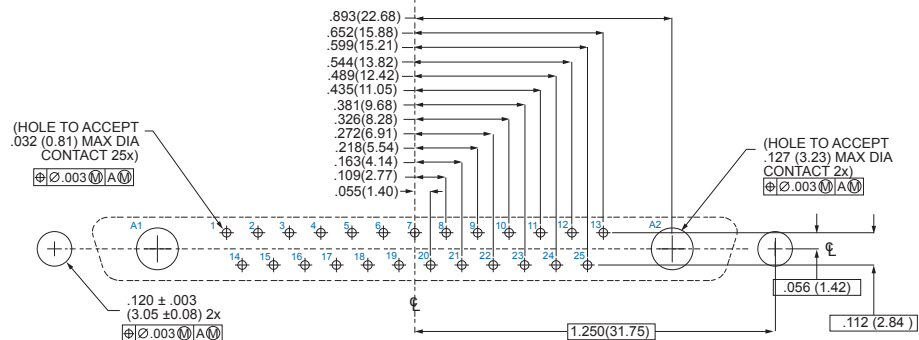

5-24P7
7 #8, 17 #20

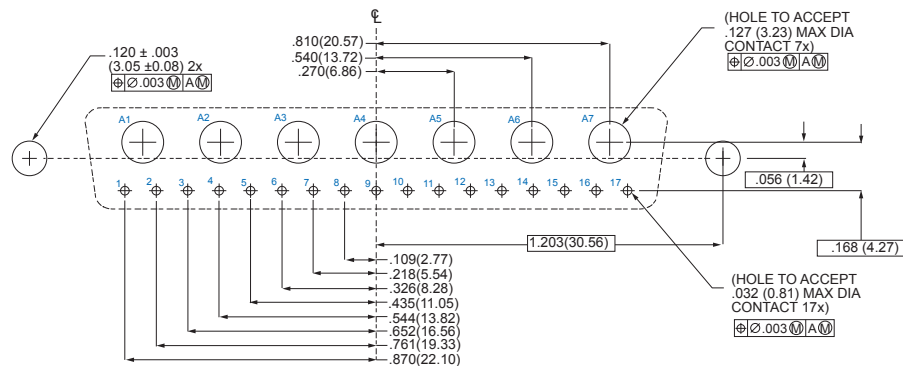

PCB FOOTPRINT FOR 280-050P AND 280-054P COMBO CONNECTORS

5-36P4
4 #8, 32 #20

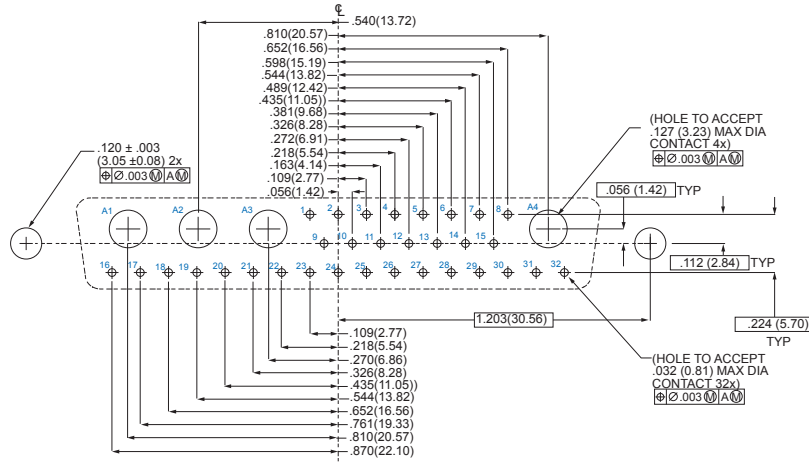

5-43P2
2 #8, 41 #20

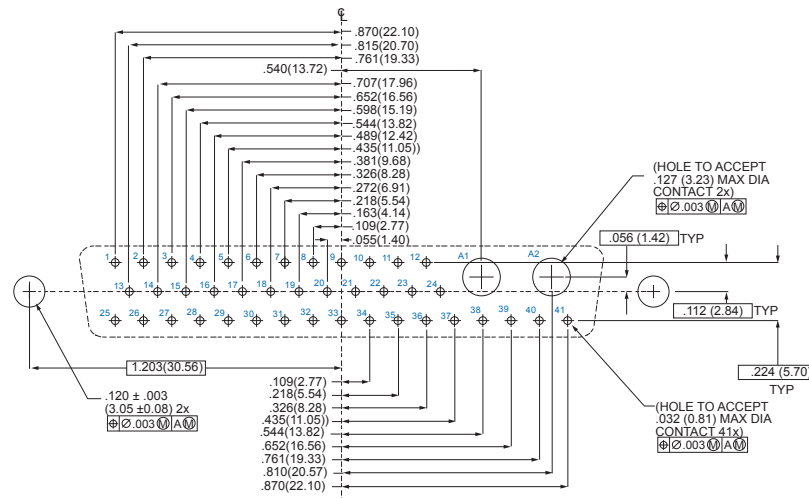

5-47P1
1 #8, 46 #20

