

SERIES 80 MIGHTY MOUSE CONNECTORS  
 Accessories, Backshells, and Tools  
 Shrink Boot Materials and Properties

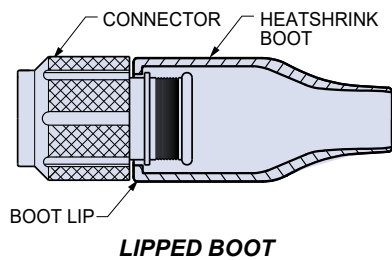

**Series 80 Connector Shrink Boots – Straight, Long Tail, 90°, and 45° angle Plus Boots for USB cables**



**Protect Your Cable Harness** with heat-shrinkable boots. These easy-to-use boots provide excellent electrical, mechanical and environmental protection. Heating the boot causes the boot to shrink onto the connector and cable. An adhesive lining bonds the boot to the connector and cable and fills small gaps for a complete seal. Choose straight cable exit or right angle exit. These lipped boots attach directly to Series 80 Mighty Mouse HD connectors with integral band platform. After shrinking, the boot lip locks into groove. Choose Type 1 high performance elastomer for extreme temperatures and excellent resistance to fuels and oils or Type 2 non-halogenated flame-retardant polyolefin for use where limited fire hazard is required.

**Material Selection Guide**

Attribute	Type 1 High Performance Semi-Rigid Elastomer	Type 2 Zero Halogen Polyolefin	Type 9 Low-Temp Flexible Polyolefin – USB ONLY –
Continuous Operating Temp.	-75° to +165°C	-40° to +130°C	-40° to +100°C
Resistance to Fuels, Oils	Excellent	Very Good	Very Good
Low Toxicity, Zero Halogen	No	Yes	No

**Type 1 High performance Elastomer**

Semi-rigid high performance boots combine excellent resistance to fuels, oils, and solvents with superior performance at extreme temperatures. Rated for 3000 hours continuous operation at +165° C, these boots fit most standard boot adapters for circular connectors. Material meets the requirements of VG95343 Type 6, BSG 198-5-DE, EN62329-102, and SAE AS5258 Type H. These boots are recommended for demanding applications such as military vehicles and petrochemical exploration. Standard Black color.

**Type 2 Zero halogen**

Halogen-free polyolefin boots meet low smoke and toxicity requirements of shipboard, transit, and aircraft systems. These Low Smoke/Zero Halogen (LSZH) boots fit most standard shrink boot adapters, including M85049 types along with Glenair Series 31 and Series 44 adapters. Oxygen index greater than 30%, smoke index less than 20, and toxicity index under 3 per 100 grams. Material meets requirements of NAVSEA 5617649, VG95343 Part 29, BSG 198-5-DF, EN62329-101, and SAE AS5258 Type G. Resistance to oils, fuels, and solvents. The boots provide strain relief and environmental protection to connector/cable transitions. Temperature rating -40° C to +130° C. Standard Black color.

**Type 9 Low Temp Flexible Polyolefin (Standard for USB)**

Lipped Straight USB Shrink Boots are available only in Type 9 Flexible Polyolefin which is designed for a low installation temperature of less than 80°C. Operating temperature range of -40° C to 100° C. Standard Black color.

ACCESSORIES, BACKSHELLS, AND TOOLS

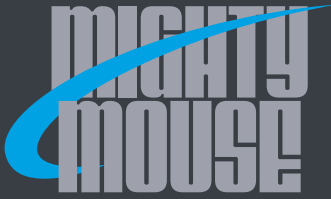

# SERIES 80 MIGHTY MOUSE CONNECTORS Accessories, Backshells, and Tools Shrink Boot Materials and Properties



## ADHESIVE-LINED BOOT MATERIAL PROPERTIES

Heat-shrink boots are not watertight unless equipped with factory-installed or user-installed adhesives. When heat is applied to the boot, the adhesive melts and fixes the boot to the adapter and cable jacket to provide the necessary sealing as well as mechanical strain-relief. Hot melt thermoplastic polyamide adhesive is compatible with most cable jackets, economical and easy to install.

Shrink Boot Typical Material Properties			
Property	Type 1 High Performance Elastomer	Type 2 Zero Halogen Polyolefin	Type 9* Low Temperature Flexible Polyolefin
Flexibility	Semi-rigid	Semi-flexible	Flexible
Operating Temperature Range	-75°C to +165°C	-40°C to +130°C	-40°C to +100°C
Shrink Temperature (min.)	135°C	135°C	<80°C
Tensile Strength (psi)	1700	1100	1740
Elongation (% min.)	400	250	500
Long Term Heat Aging	3000 hrs, 150°C	3000 hrs, 135°C	168 hrs, 150°C
Heat Shock	4 hrs, 215°C	4 hrs, 215°C	4 hrs, 160°C
Heat Aging	168 hrs, 160°C	168 hrs, 160°C	168 hrs, 160°C
Dielectric Strength (V/mil)	300	380	10 M
Volume Resistivity (ohms-cm)	10 <sup>13</sup>	10 <sup>12</sup>	10 <sup>12</sup>
Water Absorption (%)	0.5	0.5	0.5
Flammability	Burn Time <15 sec Burn Length <25mm	Burn Time <15 sec Burn Length <25mm	Burn Time <120 sec Burn Length <25mm
RoHS Compliant	Yes	Yes	Yes
Oxygen Index (% min.)	N/A	30	N/A
Temperature Index (°C)	N/A	250	N/A
Smoke Index (max.)	N/A	20	N/A
Toxicity Index (max.)	N/A	3	N/A

\* Note: Type 9 Low-Temp Flexible Polyolefin is the standard material for the USB Shrink Boot.

Shrink Boot Fluid Resistance		
Fluid	Type 1 High Performance Elastomer	Type 2 Zero Halogen Polyolefin
Lubricating Oil	Very good	Good
Hydraulic Fluid	Very Good	Good
Aviation Fuel	Very Good	Good
Gasoline	Very Good	Fair
De-Icing Fluid	Excellent	Very Good
Automotive Diesel	Good	Fair

W1 and W2 Adhesive Properties		
Attribute	W1 Standard High Temperature Hot Melt Adhesive (All Boots Except USB)	W2 Standard Hot Melt Adhesive For USB Type 9 Boots Only
Boot Material Compatibility	Type 1 and 2	Type 9 Only
Continuous Operating Temp.	-65° to +125°C	-40° to +80°C
Resistance to Fuels, Oils & Fluids	Good	Good
Low Toxicity, Zero Halogen	Yes	Yes

Material Color Options for Type 1 High Performance Elastomer Only Add Optional Color Mod Code to End of Any Type 1 Material Part Number					
Mod Code	Color	Similar to (Reference)	Mod Code	Color	Similar to (Reference)
632 B	Blue	PANTONE 3005U	632 R	Red	PANTONE 1797U
632 E	Grey	FED-STD-595; #36270	632 T	Tan	FED-STD-595; #33446
632 G	Green	PANTONE 355U	632 W	White	FED-STD-595; #37875
632 P	Purple	FED-STD-595; #37100	632 Y	Yellow	PANTONE YELLOW U
632 O	Orange	FED-STD-595; #32300	Standard	Black	FED-STD-595; #37038

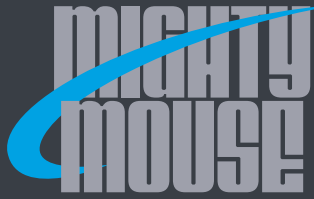

# SERIES 80 MIGHTY MOUSE CONNECTORS Accessories, Backshells, and Tools Shrink Boot Types



## LIPPED STRAIGHT SHRINK BOOTS-TYPE 1 FLAME RETARDANT ELASTOMER

- 75° C to +165° C
- Excellent resistance to fuels, oils, solvents and heat.

Fully recovered boot shown. As supplied part will vary.



Boot Size	Shell Size			Part Number Pre-Coated with W1 Hi-Temp Hot-Melt Adhesive
	Series 800, 801, 802, 803, 804	Series 805	Series 811	
1	5/6	8	5	809S060-1
2	7	9	6,7	809S060-2
3	8, 9	10, 11	8,9	809S060-3
4	10, 11, 12, 13	12, 15	N/A	809S060-4
5	14, 15, 16, 17	18, 19	N/A	809S060-5
6	19, 21	23	N/A	809S060-6

## LIPPED STRAIGHT SHRINK BOOTS- TYPE 2 ZERO HALOGEN

- Low Smoke, Zero Halogen
- Meets U.S. and E.U. toxicity requirements.

Fully recovered boot shown. As supplied part will vary.



Boot Size	Shell Size			Part Number Pre-Coated with W1 Hi-Temp Hot-Melt Adhesive
	Series 800, 801, 802, 803, 804	Series 805	Series 811	
1	5/6	8	5	809S060-1H
2	7	9	6,7	809S060-2H
3	8, 9	10, 11	8,9	809S060-3H
4	10, 11, 12, 13	12, 15	N/A	809S060-4H
5	14, 15, 16, 17	18, 19	N/A	809S060-5H
6	19, 21	23	N/A	809S060-6H

## LIPPED 90° RIGHT ANGLE SHRINK BOOTS- TYPE 1 HIGH PERFORMANCE ELASTOMER

- 75° C to +165° C
- Excellent resistance to fuels, oils, solvents and heat.

Fully recovered boot shown. As supplied part will vary.



Boot Size	Shell Size			Part Number Pre-Coated with W1 Hi-Temp Hot-Melt Adhesive
	Series 800, 801, 802, 803, 804	Series 805	Series 811	
1	5/6	8	5	809A060-1
2	7	9	6,7	809A060-2
3	8, 9	10, 11	8,9	809A060-3
4	10, 11, 12, 13	12, 15	N/A	809A060-4
5	14, 15, 16, 17	18, 19	N/A	809A060-5
6	19, 21	23	N/A	809A060-6

## LIPPED 90° RIGHT ANGLE SHRINK BOOTS- TYPE 2 ZERO HALOGEN

- Low Smoke, Zero Halogen
- Meets U.S. and E.U. toxicity requirements.

Fully recovered boot shown. As supplied part will vary.



Boot Size	Shell Size			Part Number Pre-Coated with W1 Hi-Temp Hot-Melt Adhesive
	Series 800, 801, 802, 803, 804	Series 805	Series 811	
1	5/6	8	5	809A060-1H
2	7	9	6,7	809A060-2H
3	8, 9	10, 11	8,9	809A060-3H
4	10, 11, 12, 13	12, 15	N/A	809A060-4H
5	14, 15, 16, 17	18, 19	N/A	809A060-5H
6	19, 21	23	N/A	809A060-6H

## LIPPED 45° ANGLE SHRINK BOOTS- TYPE 1 HIGH PERFORMANCE ELASTOMER

- 75° C to +165° C
- Excellent resistance to fuels, oils, solvents and heat.

Fully recovered boot shown. As supplied part will vary.



Boot Size	Shell Size		Part Number Pre-Coated with W1 Hi-Temp Hot-Melt Adhesive
	Series 800, 801, 802, 803, 804	Series 805	
1	5/6	8	809B060-1
2	7	9	809B060-2
3	8, 9	10, 11	809B060-3
4	10, 11, 12, 13	12, 15	809B060-4
5	14, 15, 16, 17	18, 19	809B060-5
6	19, 21	23	809B060-6

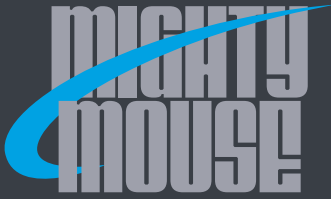

# SERIES 80 MIGHTY MOUSE CONNECTORS Accessories, Backshells, and Tools



## Shrink Boot Types

### LIPPED 45° ANGLE SHRINK BOOTS- TYPE 2 ZERO HALOGEN

- Low Smoke, Zero Halogen
- Meets U.S. and E.U. toxicity requirements.



Boot Size	Shell Size		Part Number
	Series 800, 801, 802, 803, 804	Series 805	Pre-Coated with W1 Hi-Temp Hot-Melt Adhesive
1	5/6	8	809B060-1H
2	7	9	809B060-2H
3	8, 9	10, 11	809B060-3H
4	10, 11, 12, 13	12, 15	809B060-4H
5	14, 15, 16, 17	18, 19	809B060-5H
6	19, 21	23	809B060-6H

### LIPPED STRAIGHT LONG TAIL SHRINK BOOTS- TYPE I HIGH PERFORMANCE ELASTOMER

- -75° C to +165° C
- Excellent resistance to fuels, oils, solvents and heat.



Boot Size	Shell Size		Part Number
	Series 800, 801, 802, 803, 804	Series 805	Pre-Coated with W1 Hi-Temp Hot-Melt Adhesive
1	5/6	8	809SL060-1
2	7	9	809SL060-2
3	8/9	10/11	809SL060-3
4	10/11/12/13	12/15	809SL060-4

### LIPPED STRAIGHT LONG TAIL SHRINK BOOTS- TYPE 2 ZERO HALOGEN

- Low Smoke, Zero Halogen
- Meets U.S. and E.U. toxicity requirements.



Boot Size	Shell Size		Part Number
	Series 800, 801, 802, 803, 804	Series 805	Pre-Coated with W1 Hi-Temp Hot-Melt Adhesive
1	5/6	8	809SL060-1H
2	7	9	809SL060-2H
3	8/9	10/11	809SL060-3H
4	10/11/12/13	12/15	809SL060-4H

### LIPPED STRAIGHT USB SHRINK BOOTS- TYPE 9 LOW-TEMP FLEXIBLE POLYOLEFIN

- -40° C to +100° C
- Same excellent physical properties within a limited temperature range.



Boot Size	Shell Size	Part Number
	Series 801, 804, 805	Pre-Coated with W2 Hot-Melt Adhesive
1	7, 8	809SU060-1

Contact the factory for additional material types and adhesive options or refer to the the Series 77 catalog for complete details. Additional material types include:

Type 3: 2040 Flexible Polyolefin  
 Type 5: 2050 Viton  
 Type 6: 2051 Elastomer Polymer Alloy

Type 7: 2071 Semi-Rigid Polyolefin  
 Type 8: 2008 Space Grade, Low Outgassing

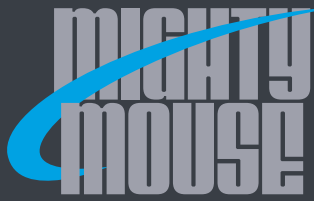

**SERIES 80 MIGHTY MOUSE CONNECTORS**  
**Accessories, Backshells, and Tools**  
**Shrink Boot Dimensions**



**LIPPED STRAIGHT SHRINK BOOTS- DIMENSIONS**

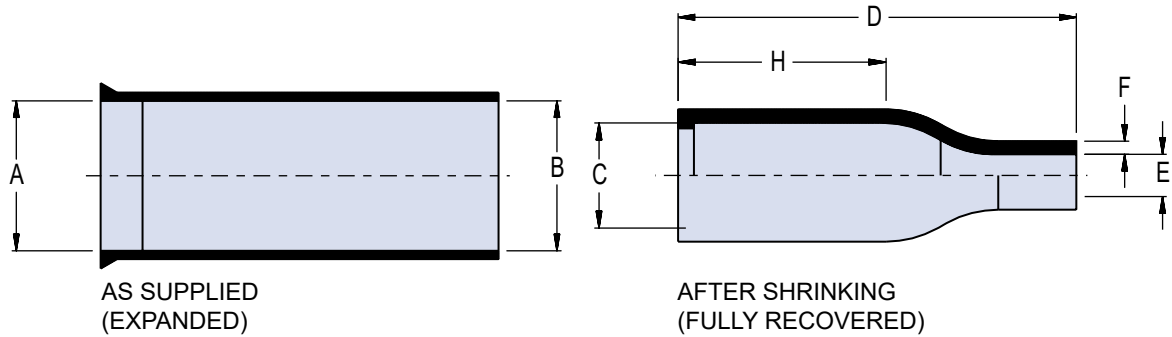

Boot Size	A Min.	B Min.	C Max.	D Ref.	E Max.	F Ref.	H Ref.	Cable Range	
								Maximum	Minimum
1	.390 (9.91)	.390 (9.91)	.260 (6.60)	1.370 (34.80)	.080 (2.03)	.030 (0.76)	.750 (19.05)	.230 (5.84)	.100 (2.54)
2	.669 (16.99)	.669 (16.99)	.300 (7.62)	1.500 (38.10)	.140 (3.56)	.032 (0.81)	.750 (19.05)	.500 (12.70)	.170 (4.32)
3	.945 (24.00)	.945 (24.00)	.390 (9.91)	1.500 (38.10)	.200 (5.08)	.035 (0.89)	.750 (19.05)	.800 (20.32)	.240 (6.10)
4	1.181 (30.00)	1.181 (30.00)	.550 (13.97)	2.170 (55.12)	.240 (6.10)	.039 (0.99)	1.180 (29.97)	1.020 (25.91)	.280 (7.11)
5	1.260 (32.00)	1.260 (32.00)	.710 (18.03)	2.640 (67.06)	.280 (7.11)	.039 (0.99)	1.300 (33.02)	1.120 (28.45)	.300 (7.62)
6	1.417 (35.99)	1.417 (35.99)	.900 (22.86)	3.150 (80.01)	.330 (8.38)	.047 (1.19)	1.570 (39.88)	1.200 (30.48)	.350 (8.89)

**LIPPED 90° RIGHT ANGLE SHRINK BOOTS- DIMENSIONS**

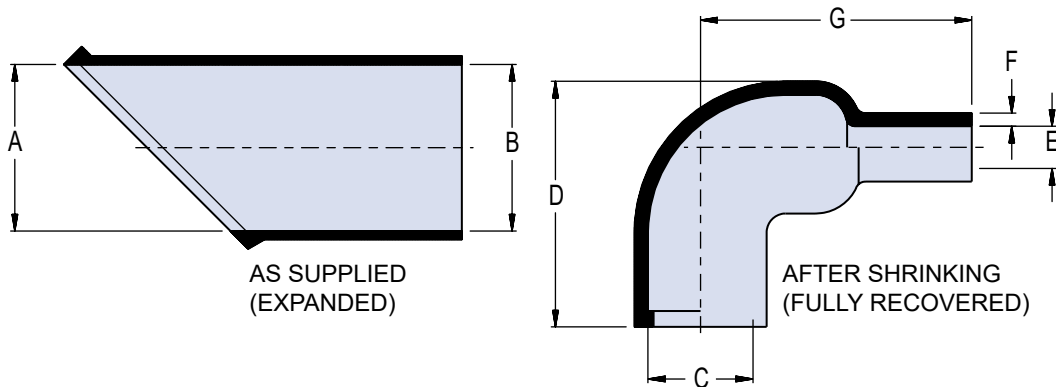

Boot Size	A Min.	B Min.	C Max.	D Ref.	E Max.	F Ref.	G Ref.	Cable Range	
								Maximum	Minimum
1	.390 (9.91)	.390 (9.91)	.260 (6.60)	.790 (20.07)	.095 (2.41)	.032 (0.81)	.750 (19.05)	.230 (5.84)	.100 (2.54)
2	.669 (16.99)	.669 (16.99)	.310 (7.87)	.790 (20.07)	.140 (3.56)	.032 (0.81)	.790 (20.07)	.500 (12.70)	.170 (4.32)
3	.945 (24.00)	.945 (24.00)	.390 (9.91)	.980 (24.89)	.200 (5.08)	.040 (1.02)	.980 (24.89)	.800 (20.32)	.240 (6.10)
4	1.181 (30.00)	1.181 (30.00)	.530 (13.46)	1.060 (26.92)	.220 (5.59)	.046 (1.17)	1.260 (32.00)	1.020 (25.91)	.270 (6.86)
5	1.260 (32.00)	1.260 (32.00)	.710 (18.03)	1.260 (32.00)	.280 (7.11)	.052 (1.32)	1.540 (39.12)	1.120 (28.45)	.300 (7.62)
6	1.417 (35.99)	1.417 (35.99)	.900 (22.86)	1.500 (38.10)	.330 (8.38)	.052 (1.32)	1.930 (49.02)	1.200 (30.48)	.350 (8.89)

ACCESSORIES, BACKSHELLS, AND TOOLS

**LIPPED 45° ANGLE SHRINK BOOTS- DIMENSIONS**

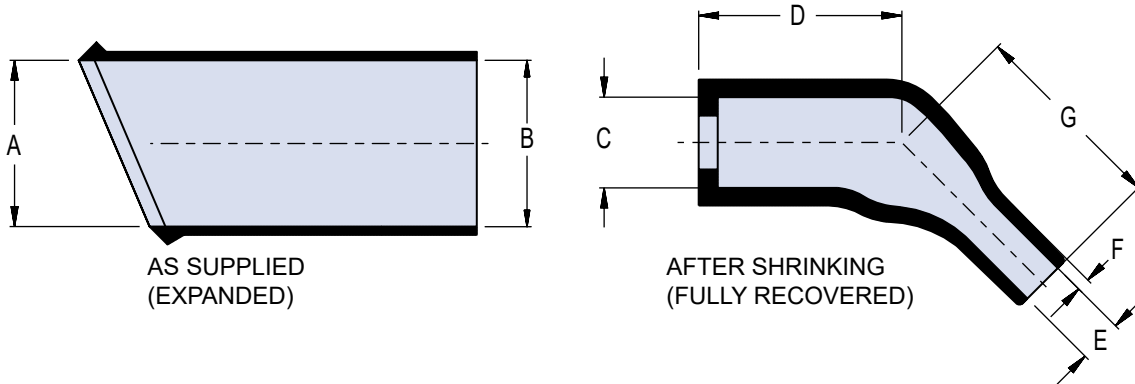

Boot Size	A Min.	B Min.	C Max.	D Ref	E Max.	F Ref.	G Ref.	Cable Range	
								Max. In.	Min. In.
1	.390 (9.91)	.390 (9.91)	.260 (6.60)	.600 (15.24)	.080 (2.03)	.030 (0.76)	.560 (14.22)	.230 (5.84)	.100 (2.54)
2	.669 (16.99)	.669 (16.99)	.300 (7.62)	.640 (16.26)	.140 (3.56)	.035 (0.89)	.620 (15.75)	.500 (12.70)	.170 (4.32)
3	.945 (24.00)	.945 (24.00)	.390 (9.91)	.500 (12.70)	.160 (4.06)	.040 (1.02)	.750 (19.05)	.800 (20.32)	.240 (6.10)
4	1.181 (30.00)	1.181 (30.00)	.550 (13.97)	.748 (19.00)	.230 (5.84)	.043 (1.09)	1.180 (29.97)	1.020 (25.91)	.280 (7.11)
5	1.260 (32.00)	1.260 (32.00)	.710 (18.03)	.984 (24.99)	.280 (7.11)	.065 (1.65)	1.380 (35.05)	1.120 (28.45)	.300 (7.62)
6	1.417 (35.99)	1.417 (35.99)	.900 (22.86)	1.260 (32.00)	.330 (8.38)	.065 (1.65)	1.570 (39.88)	1.200 (30.48)	.350 (8.89)

**LIPPED STRAIGHT LONG TAIL SHRINK BOOTS- DIMENSIONS**

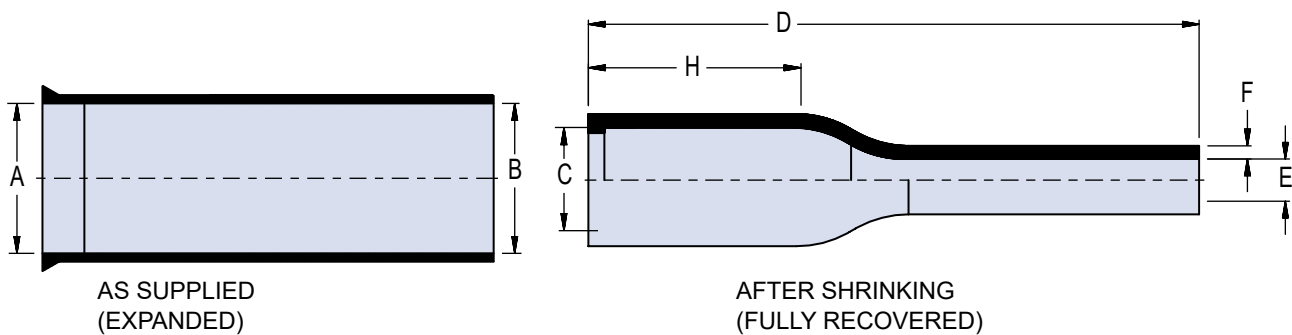

Boot Size	A Min.	B Min.	C Max.	D Ref	E Max.	F Ref.	H Ref.	Cable Range	
								Max. In.	Min. In.
1	.390 (9.91)	.390 (9.91)	.280 (7.11)	2.500 (63.50)	.080 (2.03)	.045 (1.14)	.750 (19.05)	.230 (5.84)	.100 (2.54)
2	.669 (16.99)	.669 (16.99)	.310 (7.87)	2.500 (63.50)	.140 (3.56)	.045 (1.14)	.750 (19.05)	.500 (12.70)	.170 (4.32)
3	.945 (24.00)	.945 (24.00)	.390 (9.91)	2.500 (63.50)	.200 (5.08)	.045 (1.14)	.750 (19.05)	.800 (20.32)	.240 (6.10)
4	1.181 (30.00)	1.181 (30.00)	.550 (13.97)	3.000 (76.20)	.240 (6.10)	.045 (1.14)	1.180 (29.97)	1.020 (25.91)	.280 (7.11)

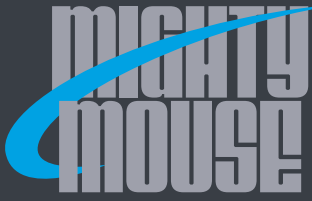

SERIES 80 MIGHTY MOUSE CONNECTORS  
 Accessories, Backshells, and Tools  
 Shrink Boot Dimensions



**LIPPED STRAIGHT USB SHRINK BOOTS- DIMENSIONS**

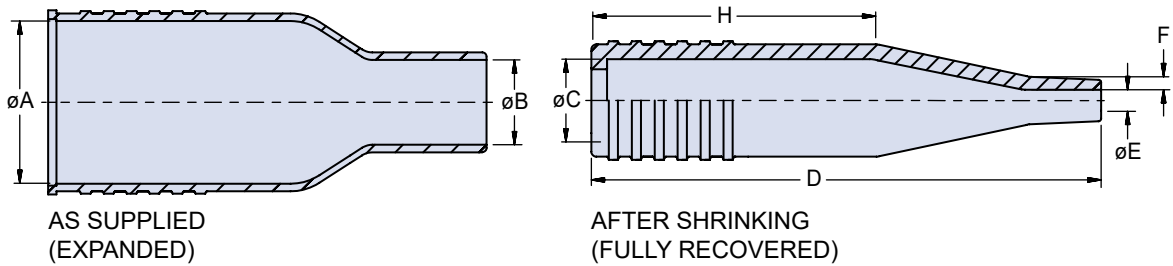

Boot Size	A Min.		B Min.		C Max.		D Ref		E Max.		F Ref.		H Ref.		Cable Range			
	In.	mm.	In.	mm.	In.	mm.	In.	mm.	In.	mm.	In.	mm.	In.	mm.	Max. In.	Max. mm.	Min. In.	Min. mm.
1	.550	13.97	.360	9.14	.330	8.38	2.000	50.80	.090	2.29	.055	1.40	1.130	28.70	.250	6.35	.090	2.29