

Series 66 Protective Covers

for MIL-DTL-38999 Series IV Connectors

660-031 Receptacle Cover

M38999/IV Receptacle Cover











660-031 protective cover fits MIL-DTL-38999 Series IV breech-lock receptacle connectors. Universal polarization. Silicone gasket. Gold plated copper alloy detent spring provides positive lock. Blue stripe indicates master keyway location. Aluminum or stainless steel, with stainless steel fittings. Optional ground spring is copper alloy, gold plated.

TABLE 1 MATERIAL / FINISH

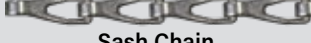
Aluminum		Stainless Steel	
G	Hardcoat Anodize	Z1	Passivate
M	Electroless Nickel	ZL	Nickel
NF	Olive Drab Cadmium		
MT	Nickel-PTFE		
ZR	Black Zinc-Nickel		
TZ	Tin-Zinc		

TABLE 2 ATTACHMENT TYPE

D	 SST Bead Chain .125 (3.2) diameter, size 6, -65 to +200 °C
F	 Wire Rope, Blue Nylon Jacket 6/6 nylon over stainless steel rope, fair flexibility, good abrasion resistance, -55 to +100 °C
G	 Black Nylon Rope Very flexible, good abrasion and fuel resistance, .094 (2.4) diameter, -55 to +100 °C
H	 Wire Rope, Clear FEP Jacket Clear FEP jacket over SST rope, fair flexibility, good abrasion resistance, .100" diameter, -65 to +200 °C
S	 Sash Chain #8 sash chain, stainless steel. Length tolerance is ± one link .280 (Z1)
SK	 Nylon Rope with Slip Knot Very flexible, good abrasion and fuel resistance, .094 (2.4) diameter. Length includes .5" (13mm) dia. loop, -55 to +100 °C
T	 SST Wire Rope, No Jacket Good flexibility, good abrasion resistance, .047 (1.2) diameter, passivated, -65 to +200 °C
U	 Wire Rope, Black Polyurethane Stainless steel rope with black polyurethane coating, flexible, excellent abrasion resistance and resistance to fuels, .080" (2mm) diameter, -55 to +125 °C

PART NUMBER

660-031	M	23	F	4	-102	G			
Base P/N	660-031								
Material/Finish	See Table 1								
Shell Size	Shell Size	11	13	15	17	19	21	23	25
	Size Code	11	13	15	17	19	21	23	25
Attachment Type	N	No Attachment See Table 2 for Attachment Types							
Attachment Length	Omit for Attachment Type N Length in One Inch Increments								
Attachment Ring	Omit for Attachment Types N and SK -00 No Ring See Table 3 for Attachment Ring Codes								
Ground Spring	Omit for None G Ground Spring								

Shell Size	ø E Max In.	ø E Max mm.	ø F Max In.	ø F Max mm.
11 (B)	.875	22.2	.776	19.7
13 (C)	1.000	25.4	.902	22.9
15 (D)	1.125	28.6	1.039	26.4
17 (E)	1.250	31.8	1.150	29.2
19 (F)	1.375	34.9	1.276	32.4
21 (G)	1.500	38.1	1.402	35.6
23 (H)	1.625	41.3	1.528	38.8
25 (J)	1.750	44.5	1.650	41.9

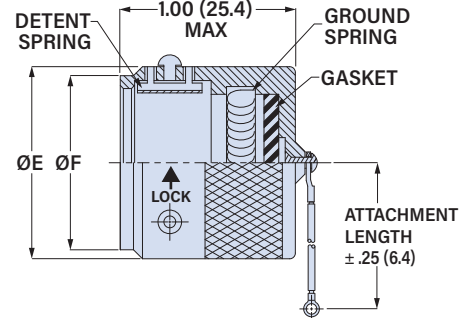



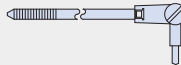

TABLE 3 ATTACHMENT RING

EYELET		STYLE A RING		STYLE B RING		SPLIT RING	
							
Code	Eyelet I.D. ±.010 (0.3)	Code	Ring I.D. ±.015 (0.4)	Code	Ring I.D. ±.015 (0.4)	Code	Ring I.D. ±.015 (0.4)
-06	.125 (3.2)	-095	.312 (7.9)	-10	.593 (15.1)	-50	.425 (10.8)
-01	.140 (3.6)	-100	.391 (9.9)	-12	.718 (18.2)	-52	.485 (12.3)
-09	.156 (4.0)	-101	.516 (13.1)	-13	.765 (19.4)	-54	.640 (16.3)
-05	.167 (4.2)	-103	.641 (16.3)	-14	.844 (21.4)	-56	.750 (19.1)
-02	.182 (4.6)	-104	.708 (18.0)	-15	.890 (22.6)	-58	.890 (22.6)
-03	.191 (4.9)	-105	.766 (19.5)	-17	1.015 (25.8)	-60	1.015 (25.8)
-04	.197 (5.0)	-106	.896 (22.8)	-19	1.140 (29.0)	-62	1.095 (27.8)
-07	.218 (5.5)	-107	1.016 (25.8)	-20	1.203 (30.6)	-64	1.130 (28.7)
		-108	1.141 (29.0)	-21	1.265 (32.1)	-66	1.250 (31.8)
		-208	1.203 (30.6)	-22	1.343 (34.1)	-68	1.350 (34.3)
		-109	1.266 (32.2)	-24	1.484 (37.7)	-70	1.375 (34.9)
		-110	1.391 (35.3)	-27	1.640 (41.7)	-72	1.485 (37.7)
		-111	1.521 (38.6)	-29	1.765 (44.8)	-74	1.625 (41.3)
		-112	1.641 (41.7)	-30	1.890 (48.0)	-76	1.750 (44.5)
		-113	1.766 (44.9)	-31	1.953 (49.6)	-80	1.980 (50.3)
		-114	1.891 (48.0)	-33	2.077 (52.8)	-84	2.235 (56.8)
		-115	2.078 (52.8)	-36	2.187 (55.5)	-86	2.310 (58.7)
CABLE TIE							
							
-WS	Black 6/6 nylon cable tie 1.77 (45.0) max. wire bundle dia.						