

For Strain Relief Styles
H, A, M and D

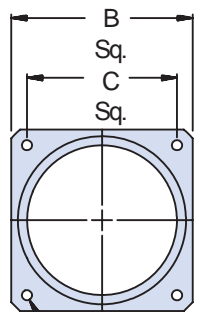

D Mounting Holes
(4 Places)

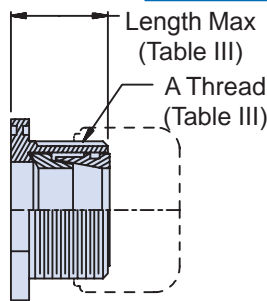

Style 1
Type B - Front Mount
RFI/EMI

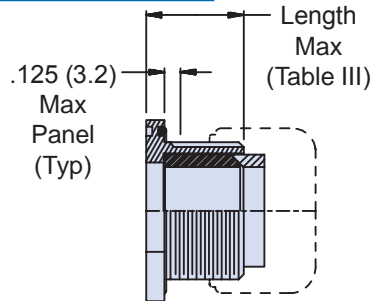

Style 2
Type A - Rear Mount
Environmental

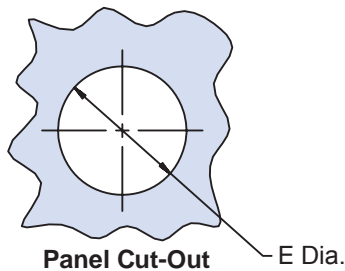

Panel Cut-Out
E Dia.

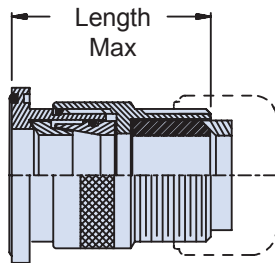

Style 3 -
Type B - Front Mount
RFI/EMI Environmental

APPLICATION NOTES

1. Assembly identified with manufacturer's name and part number, space permitting.
2. Cable range is defined as the accommodations range for the wire bundle or cable. Dimensions shown are not intended for inspection criteria.
3. Material / Finish: See Table II.
4. Metric dimensions (mm) are indicated in parentheses.

STYLE H
Heavy Duty

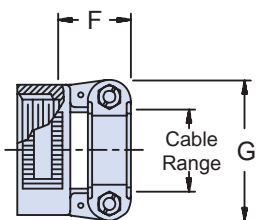

STYLE A
Medium Duty

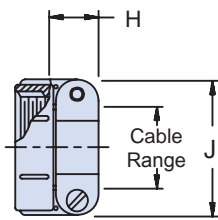

STYLE M
Medium Duty

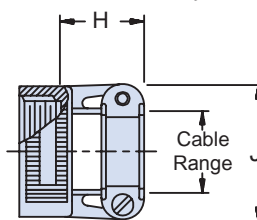

STYLE D
Medium Duty

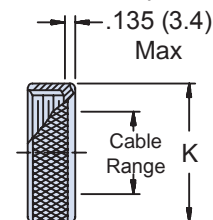

630-006
Square Flange Feed-Through Fittings
RFI/EMI Environmental



Feed-Throughs

TABLE III: Dash Number, Cable Range and Dimensions (Continued Below)

Dash No.	Clamp Style	Clamp Size	Cable Range		A Thread	B	C Sq.	D Dia -.000	E Dia -.000
			Min	Max	Unified	Max	± .010 (± .3)	+ .015 (+ .4)	+ .030 (+.8)
01	1, 2, 4	03	.157 (4.0)	.250 (6.4)	1/2 -28	.885 (22.5)	.593 (15.1)	.120 (3.0)	.250 (6.4)
02	3	03	.157 (4.0)	.250 (6.4)	1/2 -28	.885 (22.5)	.593 (15.1)	.120 (3.0)	.250 (6.4)
03	1,2, 4	04	.187 (4.7)	.312 (7.9)	5/8 -24	1.104 (28.0)	.812 (20.6)	.120 (3.0)	.312 (7.9)
04	3	04	.187 (4.7)	.312 (7.9)	5/8 -24	1.104 (28.0)	.812 (20.6)	.120 (3.0)	.312 (7.9)
05	1, 2, 4	06	.281 (7.1)	.437 (11.1)	3/4 -20	1.197 (30.4)	.906 (23.0)	.120 (3.0)	.437 (11.1)
06	3	06	.281 (7.1)	.437 (11.1)	3/4 -20	1.197 (30.4)	.906 (23.0)	.120 (3.0)	.437 (11.1)
07	1,2, 4	08	.344 (8.7)	.562 (14.3)	7/8 -20	1.291 (32.8)	.968 (24.6)	.120 (3.0)	.562 (14.3)
08	3	08	.387 (9.8)	.562 (14.3)	7/8 -20	1.291 (32.8)	.968 (24.6)	.120 (3.0)	.562 (14.3)
09	1, 2, 4	10	.375 (9.5)	.625 (15.9)	1 -20	1.385 (35.2)	1.062 (27.0)	.120 (3.0)	.625 (15.9)
10	3	10	.512 (13.0)	.625 (15.9)	1 -20	1.385 (35.2)	1.062 (27.0)	.120 (3.0)	.625 (15.9)
11	1,2, 4	12	.438 (11.1)	.750 (19.1)	1 3/16 -18	1.635 (41.5)	1.250 (31.8)	.120 (3.0)	.750 (19.1)
12	3	12	.575 (14.6)	.750 (19.1)	1 3/16 -18	1.635 (41.5)	1.250 (31.8)	.120 (3.0)	.750 (19.1)
13	1, 2, 4	16	.625 (15.9)	.937 (23.8)	1 7/16 -18	1.760 (44.7)	1.375 (34.9)	.147 (3.7)	.937 (23.8)
14	3	16	.625 (15.9)	.937 (23.8)	1 7/16 -18	1.760 (44.7)	1.375 (34.9)	.147 (3.7)	.937 (23.8)
15	1,2, 4	20	.875 (22.2)	1.250 (31.8)	1 3/4 -18	2.010 (51.1)	1.562 (39.7)	.147 (3.7)	1.250 (31.8)
16	3	20	.875 (22.2)	1.250 (31.8)	1 3/4 -18	2.010 (51.1)	1.562 (39.7)	.147 (3.7)	1.250 (31.8)
17	1, 2, 4	24	1.000 (25.4)	1.375 (34.9)	2 -18	2.260 (57.4)	1.750 (44.5)	.173 (4.4)	1.375 (34.9)
18	3	24	1.000 (25.4)	1.375 (34.9)	2 -18	2.260 (57.4)	1.750 (44.5)	.173 (4.4)	1.375 (34.9)
19	1,2, 4	28	1.250 (31.8)	1.625 (41.3)	2 1/4 -16	2.510 (63.8)	1.938 (49.2)	.173 (4.4)	1.625 (41.3)
20	3	28	1.250 (31.8)	1.625 (41.3)	2 1/4 -16	2.510 (63.8)	1.938 (49.2)	.173 (4.4)	1.625 (41.3)
21	1, 2, 4	32	1.437 (36.5)	1.875 (47.6)	2 1/2 -16	2.781 (70.6)	2.188 (55.6)	.173 (4.4)	1.875 (47.6)
22	3	32	1.437 (36.5)	1.875 (47.6)	2 1/2 -16	2.781 (70.6)	2.188 (55.6)	.173 (4.4)	1.875 (47.6)
23	1,2, 4	40	1.875 (47.6)	2.375 (60.3)	3 -16	3.281 (83.3)	2.625 (66.7)	.173 (4.4)	2.375 (60.3)
24	3	40	1.875 (47.6)	2.375 (60.3)	3 -16	3.281 (83.3)	2.625 (66.7)	.173 (4.4)	2.375 (60.3)

TABLE III: (Continued from Above)

Dash No.	Style	F Max	G Max	H Max	J Max	K Max	Length Max
01	1, 2, 4	---	---	.760 (19.3)	.843 (21.4)	.630 (16.0)	.971 (24.7)
02	3	---	---	.760 (19.3)	.843 (21.4)	.630 (16.0)	1.820 (46.2)
03	1,2, 4	.780 (19.8)	.957 (24.3)	.760 (19.3)	.906 (23.0)	.755 (19.2)	.971 (24.7)
04	3	.780 (19.8)	.957 (24.3)	.760 (19.3)	.906 (23.0)	.755 (19.2)	1.820 (46.2)
05	1,2, 4	.780 (19.8)	1.145 (29.1)	.760 (19.3)	1.093 (27.8)	.942 (23.9)	.971 (24.7)
06	3	.780 (19.8)	1.145 (29.1)	.760 (19.3)	1.093 (27.8)	.942 (23.9)	1.820 (46.2)
07	1,2, 4	.780 (19.8)	1.332 (33.8)	.760 (19.3)	1.187 (30.1)	1.067 (27.1)	.971 (24.7)
08	3	.780 (19.8)	1.332 (33.8)	.760 (19.3)	1.187 (30.1)	1.067 (27.1)	1.820 (46.2)
09	1, 2, 4	.780 (19.8)	1.332 (33.8)	.760 (19.3)	1.281 (32.5)	1.192 (30.3)	.971 (24.7)
10	3	.780 (19.8)	1.332 (33.8)	.760 (19.3)	1.281 (32.5)	1.192 (30.3)	1.820 (46.2)
11	1,2, 4	.811 (20.6)	1.551 (39.4)	.760 (19.3)	1.500 (38.1)	1.380 (35.1)	1.031 (26.2)
12	3	.811 (20.6)	1.551 (39.4)	.760 (19.3)	1.500 (38.1)	1.380 (35.1)	1.820 (46.2)
13	1,2, 4	.905 (23.0)	1.770 (45.0)	1.073 (27.3)	1.719 (43.7)	1.535 (39.0)	1.031 (26.2)
14	3	.905 (23.0)	1.770 (45.0)	1.073 (27.3)	1.719 (43.7)	1.535 (39.0)	1.820 (46.2)
15	1,2, 4	1.092 (27.7)	2.113 (53.7)	1.323 (33.6)	2.062 (52.4)	1.848 (46.9)	1.031 (26.2)
16	3	1.092 (27.7)	2.113 (53.7)	1.323 (33.6)	2.062 (52.4)	1.848 (46.9)	1.820 (46.2)
17	1, 2, 4	1.124 (28.5)	2.363 (60.0)	1.323 (33.6)	2.312 (58.7)	2.255 (57.3)	1.095 (27.8)
18	3	1.124 (28.5)	2.363 (60.0)	1.323 (33.6)	2.312 (58.7)	2.255 (57.3)	1.820 (46.2)
19	1,2, 4	1.399 (35.5)	2.770 (70.4)	1.572 (39.9)	2.719 (69.1)	2.505 (63.6)	1.095 (27.8)
20	3	1.399 (35.5)	2.770 (70.4)	1.572 (39.9)	2.719 (69.1)	2.505 (63.6)	1.820 (46.2)
21	1,2, 4	1.399 (35.5)	3.020 (76.7)	1.572 (39.9)	2.969 (75.4)	2.755 (70.0)	1.095 (27.8)
22	3	1.399 (35.5)	3.020 (76.7)	1.572 (39.9)	2.969 (75.4)	2.755 (70.0)	1.940 (49.3)
23	1,2, 4	---	---	1.572 (39.9)	3.531 (89.7)	3.255 (82.7)	1.220 (31.0)
24	3	---	---	1.572 (39.9)	3.531 (89.7)	3.255 (82.7)	2.060 (52.3)

F