

**MIL-DTL-38999 Series III Type space-grade blind-mate  
253-014, 253-015 Jam-nut mount plug and receptacle**



Part Number Development										
Sample Part Number	253-014			-07	ME	25-35	P	N	NS	H
Series / Basic Part No.	253 = Blind-mate -014 = Plug (fixed mount) -015 = Receptacle (float mount)									
Connector Style	07 = Jam nut mount; contact factory for wall mount receptacles									
Material/Finish	ME = Aluminum, electroless nickel ZL = CRES, electrodeposited nickel MT = Aluminum, nickel PTFE Z1 = CRES, passivated									
Shell Size - Insert Arrangement*	Per MIL-STD-1560; symmetrical layouts only, consult factory for complete details									
Contact Type	P = Pin, crimp removable S = Socket, crimp removable A = Pin insert, less contacts B = Socket insert, less contacts									
Alternate Polarization	A, B, C, D, E, N = Normal (Polarization for intermateability with 253-014 is per MIL-DTL-38999 Series I)									
Non Sealing	NS = Non-Sealing (omit for external elastomer seal version, applies to 253-015 only)									
Jam-Nut Type	H = Hex S = Spanner with wire holes (applies to 015 only)									

\*Refer to section A for complete details. Refer to Space-Grade Guidelines material (IAW NASA EEE INST-002) for outgassing and screening modification codes, on pages 60 and 61. Modification codes may be added directly to the end of any valid part number

ENVIRONMENTAL CONNECTORS

**253-014 FIXED JAM-NUT MOUNT PLUG WITH ROLL-ON/ROLL-OFF NOSE AND ACCESSORY THREADS**

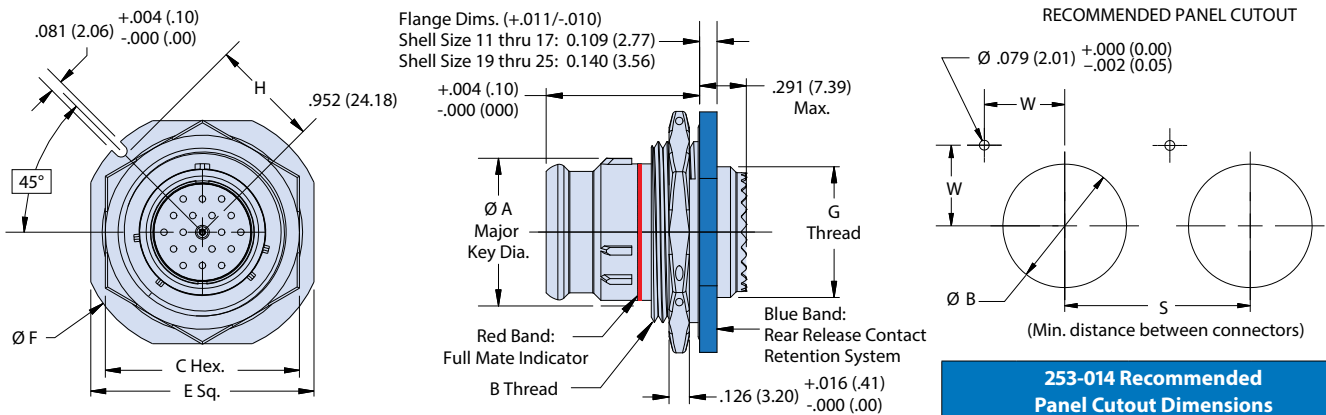

253-014 Dimensions							
Shell Size	A Max Dia.	Thread B Class 2A	C Max	E (±.016)	F Max Dia.	G Thread Class 2A	H (+0/-.008)
11	.673 (17.09)	.8125-20 UNEF	1.016 (25.81)	1.250 (31.75)	1.386 (35.20)	.5625-24	.604 (15.34)
13	.798 (20.27)	1.0000-20 UNEF	1.181 (30.00)	1.375 (34.92)	1.511 (38.38)	.6875-24	.666 (16.92)
15	.923 (23.44)	1.1250-18 UNEF	1.300 (33.02)	1.500 (38.10)	1.636 (41.55)	.8125-20	.729 (18.52)
17	1.048 (26.62)	1.2500-18 UNEF	1.457 (37.01)	1.625 (41.28)	1.761 (44.73)	.9375-20	.791 (20.09)
19	1.173 (29.79)	1.3750-18 UNEF	1.575 (40.00)	1.812 (46.02)	1.949 (49.50)	1.0625-18	.893 (22.68)
21	1.298 (32.97)	1.5000-18 UNEF	1.693 (43.00)	1.938 (49.23)	2.073 (52.65)	1.1875-18	.955 (24.26)
23	1.423 (36.14)	1.6250-18 UNEF	1.880 (47.75)	2.062 (52.37)	2.200 (55.88)	1.3125-18	1.017 (25.83)
25	1.548 (39.32)	1.7500-18 UNS	2.016 (51.21)	2.187 (55.55)	2.323 (59.00)	1.4375-18	1.096 (27.84)

253-014 Recommended Panel Cutout Dimensions			
Shell Size	W	Diameter B ±.004	S
11	.460 (11.68)	0.821 (20.85)	1.282 (32.56)
13	.504 (12.80)	1.007 (25.58)	1.417 (35.99)
15	.549 (13.94)	1.134 (28.80)	1.559 (39.60)
17	.593 (15.06)	1.259 (31.98)	1.705 (43.31)
19	.665 (16.89)	1.384 (35.15)	1.850 (46.99)
21	.709 (18.01)	1.507 (38.28)	1.992 (50.60)
23	.753 (19.13)	1.634 (41.50)	2.134 (54.20)
25	.806 (20.47)	1.759 (44.68)	2.350 (59.69)

**NOTES:**

- Glenair 253-014 is designed to mate with 253-015 with same insert arrangement.
- Stainless steel locating pin to be shipped with connector
- Misalignment capabilities are possible with 253-014, when mated to 253-015.
- Contact manufacturer for outgassing options.
- Material/finish
- Shell, jam-nut: see P/N development, finish
- Insulator: high grade rigid dielectric/N.A.
- Seals: fluorosilicone blend/N.A.
- contacts: copper alloy/gold plated

## MIL-DTL-38999 Series III Type space-grade blind-mate 253-014, 253-015 Jam-nut mount plug and receptacle

ENVIRONMENTAL CONNECTORS

### 253-015 FLOATING JAM-NUT MOUNT RECEPTACLE WITH MISALIGNMENT ACCOMMODATION AND OPTIONAL SEALING

Connector Shown Includes Sealing Option

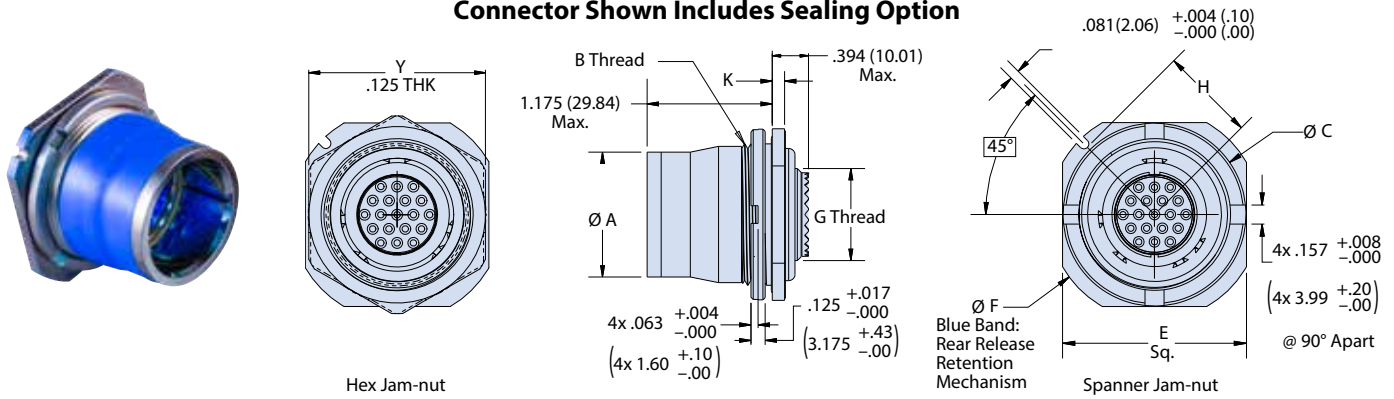

253-015 Dimensions									
Shell Size	A Max Dia.	Thread B Class 2A	C Max.	Y Hex	E ±.016(.41)	F Max Dia.	G Thd Class 2A	K +.011/.010 (+.28/.25)	H +0/--.008 (+0/--.20)
11	.853 (21.67)	1.0000-20 UNEF	1.264 (32.11)	1.181 (30.00)	1.266 (32.16)	1.500 (38.10)	.5625-24	.109 (2.77)	.666 (16.92)
13	.978 (24.84)	1.1250-18 UNEF	1.388 (35.26)	1.300 (33.02)	1.391 (35.33)	1.641 (41.68)	.6875-24	.109 (2.77)	.729 (18.52)
15	1.103 (28.02)	1.2500-18 UNEF	1.512 (38.40)	1.457 (37.01)	1.516 (38.51)	1.750 (44.45)	.8125-20	.109 (2.77)	.791 (20.09)
17	1.228 (31.19)	1.3750-18 UNEF	1.638 (41.61)	1.575 (40.00)	1.641 (41.68)	1.938 (49.23)	.9375-20	.109 (2.77)	.893 (22.68)
19	1.353 (34.37)	1.5000-18 UNEF	1.823 (46.30)	1.693 (43.00)	1.828 (46.43)	2.062 (52.37)	1.0625-18	.140 (3.56)	.955 (24.26)
21	1.478 (37.54)	1.6250-18 UNEF	1.953 (49.61)	1.880 (47.75)	1.954 (49.63)	2.188 (55.58)	1.1875-18	.140 (3.56)	1.017 (25.83)
23	1.603 (40.72)	1.7500-18 UNS	2.075 (52.71)	2.010 (51.05)	2.078 (52.78)	2.312 (58.72)	1.3125-18	.140 (3.56)	1.080 (27.43)
25	1.728 (43.89)	1.8750-16 UNS	2.122 (53.90)	2.125 (53.97)	2.128 (54.05)	2.327 (59.11)	1.4375-18	.140 (3.56)	1.086 (27.58)

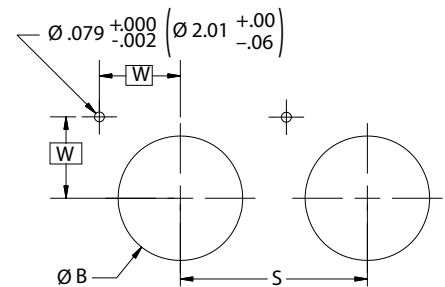
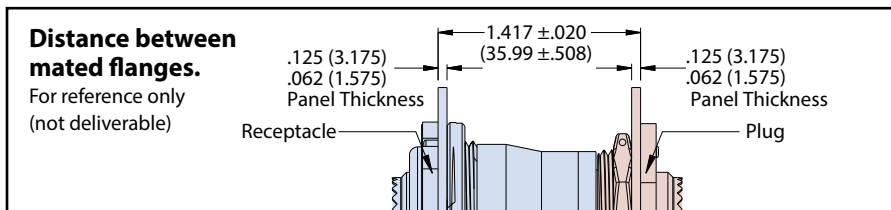

### 253-015 Misalignment Capabilities

Axial Misalignment

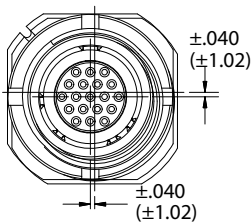

Angular Misalignment

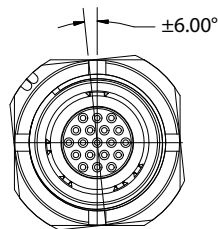

Reference Only (Not Deliverable)

Longitudinal Misalignment

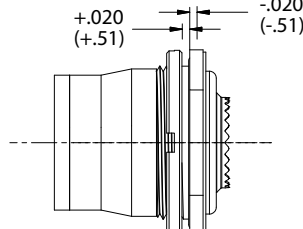

253-015 Recommended Panel Cutout Dimensions			
Shell Size	W	B Dia. ±.004 (.10)	S
11	.504 (12.80)	1.007 (25.58)	1.282 (32.56)
13	.549 (13.94)	1.134 (28.80)	1.417 (35.99)
15	.593 (15.06)	1.259 (31.98)	1.559 (39.60)
17	.665 (16.89)	1.384 (35.15)	1.705 (43.31)
19	.709 (18.01)	1.507 (38.28)	1.850 (46.99)
21	.753 (19.13)	1.634 (41.50)	1.992 (50.60)
23	.797 (20.24)	1.759 (44.68)	2.134 (54.20)
25	.799 (20.29)	1.884 (47.85)	2.262 (57.45)